

*Cardiac Radionuclide Imaging and Cost
Effectiveness*

May 1982

NTIS order #PB82-239989

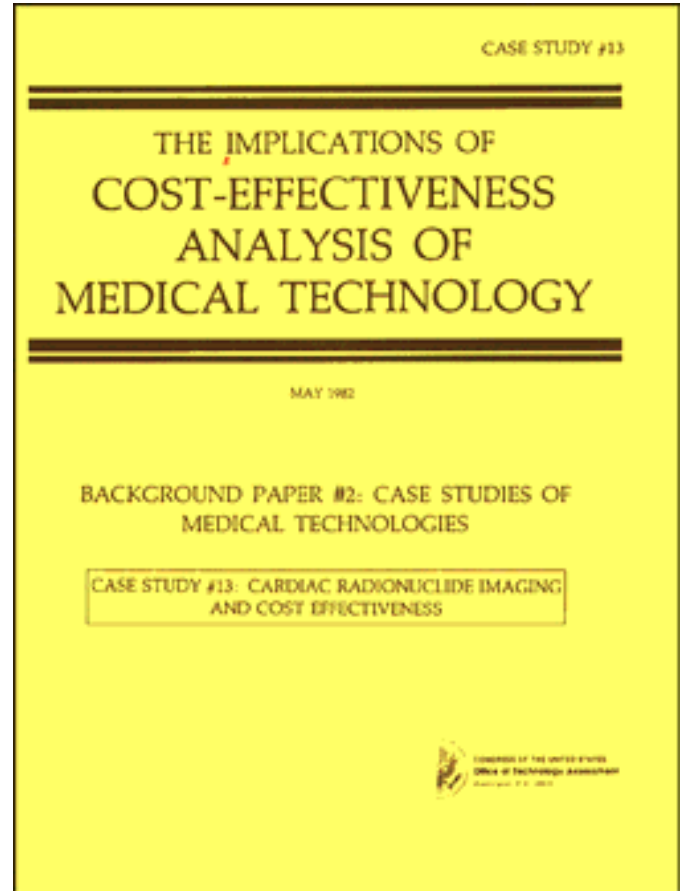

THE IMPLICATIONS OF COST-EFFECTIVENESS ANALYSIS OF MEDICAL TECHNOLOGY

MAY 1982

BACKGROUND PAPER #2: CASE STUDIES OF MEDICAL TECHNOLOGIES

CASE STUDY #13: CARDIAC RADIONUCLIDE IMAGING AND COST EFFECTIVENESS
--

William B. Stason, M. D., S.M.
Associate Professor of Health Policy and Management
Center for the Analysis of Health Practices
Harvard School of Public Health
and
Director of Health Services Research
VA Outpatient Clinic
Boston, Mass.

Eric Fortess, M. P. H., S.M.
Center for the Analysis of Health Practices
Harvard School of Public Health
Boston, Mass.

OTA Background Papers are documents that contain information believed to be useful to various parties. The information under-girds formal OTA assessments or is an outcome of internal exploratory planning and evaluation. The material is usually not of immediate policy interest such as is contained in an OTA Report or Technical Memorandum, nor does it present options for Congress to consider.



Library of Congress Catalog Card Number 80-600161

For sale by the Superintendent of Documents,
U.S. Government Printing Office, Washington, D.C. 20402

Foreword

This case study is one of 17 studies comprising Background Paper #2 for OTA's assessment, *The Implications of Cost-Effectiveness Analysis of Medical Technology*. That assessment analyzes the feasibility, implications, and value of using cost-effectiveness and cost-benefit analysis (CEA/CBA) in health care decisionmaking. The major, policy-oriented report of the assessment was published in August 1980. In addition to Background Paper #2, there are four other background papers being published in conjunction with the assessment: 1) a document which addresses methodological issues and reviews the CEA/CBA literature, published in September 1980; 2) a case study of the efficacy and cost-effectiveness of psychotherapy, published in October 1980; 3) a case study of four common diagnostic X-ray procedures, published in April 1982; and 4) a review of international experience in managing medical technology, published in October 1980. Another related report was published in September of 1979: *A Review of Selected Federal Vaccine and Immunization Policies*.

The case studies in *Background Paper #2: Case Studies of Medical Technologies* are being published individually. They were commissioned by OTA both to provide information on the specific technologies and to gain lessons that could be applied to the broader policy aspects of the use of CEA/CBA. Several of the studies were specifically requested by the Senate Committee on Finance.

Drafts of each case study were reviewed by OTA staff; by members of the advisory panel to the overall assessment, chaired by Dr. John Hogness; by members of the Health Program Advisory Committee, chaired by Dr. Frederick Robbins; and by numerous other experts in clinical medicine, health policy, Government, and economics. We are grateful for their assistance. However, responsibility for the case studies remains with the authors.



JOHN H. GIBBONS
Director

Advisory Panel on The Implications of Cost= Effectiveness Analysis of Medical Technology

John R. Hogness, Panel *Chairman*
President, Association of Academic Health Centers

Stuart H. Altman

Dean
Florence Heller School
Brandeis University

James L. Bennington

Chairman
Department of Anatomic Pathology and
Clinical Laboratories
Children's Hospital of San Francisco

John D. Chase

Associate Dean for Clinical Affairs
University of Washington School of Medicine

Joseph Fletcher

Visiting Scholar
Medical Ethics
School of Medicine
University of Virginia

Clark C. Havighurst

Professor of Law
School of Law
Duke University

Sheldon Leonard

Manager
Regulatory Affairs
General Electric Co.

Barbara J. McNeil

Department of Radiology
Peter Bent Brigham Hospital

Robert H. Moser

Executive Vice President
American College of Physicians

Frederick Mosteller

Chairman
Department of Biostatistics
Harvard University

Robert M. Sigmond

Advisor O)l Hospital Affairs
Blue Cross and Blue Shield Associations

Jane Sisk Willems

VA Scholar
Veterans Administration

OTA Staff for Background Paper #2

Joyce C. Lashof* and H. David Banta, ** *Assistant Director,
Health and Life Sciences Division, OTA*

H. David Banta* and Clyde J. Behney, ** *Health Program Manager*

Clyde J. Behney, Project Director

Kerry Britten Kemp, *** *Editor*
Virginia Cwalina, *Research Assistant*
Shirley Ann Gayheart, *Secretary*
Nancy L. Kenney, *Secretary*
Martha Finney, * * * *Assistant Editor*

Other Contributing Staff

Bryan R. Luce Lawrence Miike Michael A. Riddiough
Leonard Saxe Chester Strobel***

OTA Publishing Staff

John C. Holmes, *Publishing Officer*

John Bergling Kathie S. Boss Debra M. Datcher Joe Henson

*Until December 1981.

* From December 1981.

• "OTA contract personnel

Preface

This case study is one of 17 that comprise Background Paper #2 to the OTA project on the Implications of *Cost-Effectiveness Analysis of Medical Technology*. * The overall project was requested by the Senate Committee on Labor and Human Resources. In all, 19 case studies of technological applications were commissioned as part of that project. Three of the 19 were specifically requested by the Senate Committee on Finance: psychotherapy, which was issued separately as Background Paper #3; diagnostic X-ray, issued as Background Paper #5; and respiratory therapies. The other 16 case studies were selected by OTA staff.

In order to select those 16 case studies, OTA, in consultation with the advisory panel to the overall project, developed a set of selection criteria. Those criteria were designed to ensure that as a group the case studies would provide:

- examples of types of technologies by function (preventive, diagnostic, therapeutic, and rehabilitative);
- examples of types of technologies by physical nature (drugs, devices, and procedures);
- examples of technologies in different stages of development and diffusion (new, emerging, and established);
- examples from different areas of medicine (such as general medical practice, pediatrics, radiology, and surgery);
- examples addressing medical problems that are important because of their high frequency or significant impacts (such as cost);
- examples of technologies with associated high costs either because of high volume (for low-cost technologies) or high individual costs;
- examples that could provide informative material relating to the broader policy and methodological issues of cost-effectiveness or cost-benefit analysis (CEA/CBA); and

- examples with sufficient evaluable literature.

On the basis of these criteria and recommendations by panel members and other experts, OTA staff selected the other case studies. These 16 plus the respiratory therapy case study requested by the Finance Committee make up the 17 studies in this background paper.

All case studies were commissioned by OTA and performed under contract by experts in academia. They are authored studies. OTA subjected each case study to an extensive review process. Initial drafts of cases were reviewed by OTA staff and by members of the advisory panel to the project. Comments were provided to authors, along with OTA's suggestions for revisions. Subsequent drafts were sent by OTA to numerous experts for review and comment. Each case was seen by at least 20, and some by 40 or more, outside reviewers. These reviewers were from relevant Government agencies, professional societies, consumer and public interest groups, medical practice, and academic medicine. Academicians such as economists and decision analysts also reviewed the cases. In all, over 400 separate individuals or organizations reviewed one or more case studies. Although all these reviewers cannot be acknowledged individually, OTA is very grateful for their comments and advice. In addition, the authors of the case studies themselves often sent drafts to reviewers and incorporated their comments.

*Office of Technology Assessment, U.S. Congress, *The Implications of Cost-Effectiveness Analysis of Medical Technology* GPO stock No. 052-003 -0076 S-7 (Washington, D. C.: U.S. Government Printing Office, August 1980).

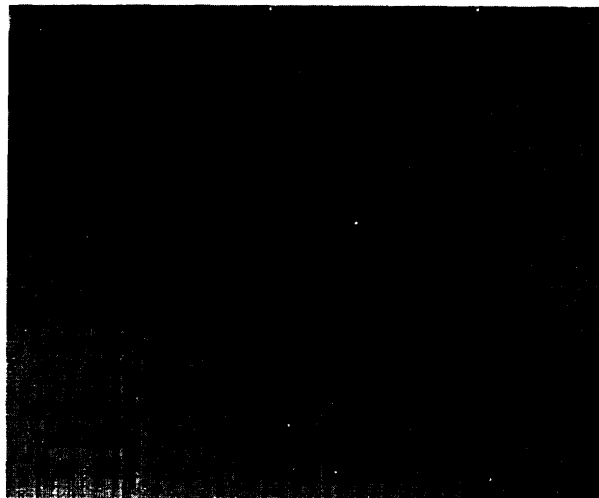



The case studies were selected and designed to fulfill two functions. The first, and primary, purpose was to provide OTA with specific information that could be used in formulating general conclusions regarding the feasibility and implications of applying CEA/CBA in health care. By examining the 19 cases as a group and looking for common problems or strengths in the techniques of CEA/CBA, OTA was able to better analyze the potential contribution that these techniques might make to the management of medical technologies and health care costs and quality. The second function of the cases was to provide useful information on the specific technologies covered. However, this was not the major intent of the cases, and

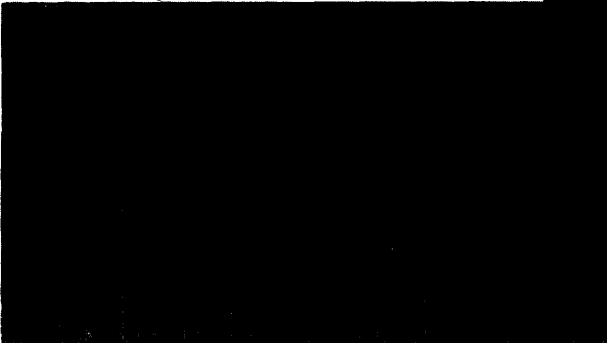

Some of the case studies are formal CEAs or CBAs; most are not. Some are primarily concerned with analysis of costs; others are more concerned with analysis of efficacy or effectiveness. Some, such as the study on end-stage renal disease, examine the role that formal analysis of costs and benefits can play in policy formulation. Others, such as the one on breast cancer surgery, illustrate how influences other than costs can determine the patterns of use of a technology. In other words, each looks at evaluation of the costs and the benefits of medical technologies from a slightly different perspec-

tive. The reader is encouraged to read this study in the context of the overall assessment's objectives in order to gain a feeling for the potential role that CEA/CBA can or cannot play in health care and to better understand the difficulties and complexities involved in applying CEA/CBA to specific medical technologies.

The 17 case studies comprising *Background Paper #2* (short titles) and their authors are:

Artificial Heart: Deborah P. Lubeck and John P. Bunker

Automated Multichannel Chemistry Analyzers: Milton C. Weinstein and Laurie A. Pearlman

Bone Marrow Transplants: Stuart O. Schweitzer and C. C. Scalzi

Breast Cancer Surgery: Karen Schachter and Duncan Neuhauser



Cervical Cancer Screening: Bryan R. Luce

Cimetidine and Peptic Ulcer Disease: Harvey V. Fineberg and Laurie A. Pearlman

Colon Cancer Screening: David M. Eddy

CT Scanning: Judith L. Wagner

Elective Hysterectomy: Carol Korenbrot, Ann B. Flood, Michael Higgins, Noralou Roos, and John P. Bunker

End-Stage Renal Disease: Richard A. Rettig

Gastrointestinal Endoscopy: Jonathan A. Showstack and Steven A. Schroeder

Neonatal Intensive Care: Peter Budetti, Peggy McManus, Nancy Barrant, and Lu Ann Heinen

Nurse Practitioners: Lauren LeRoy and Sharon Solkowitz

Orthopedic Joint Prosthetic Implants: Judith D. Bentkover and Philip G. Drew

Periodontal Disease Interventions: Richard M. Scheffler and Sheldon Rovin

Selected Respiratory Therapies: Richard M. Scheffler and Morgan Delaney

These studies will be available for sale by the Superintendent of Documents, U.S. Government Printing Office, Washington, D.C. 20402. Call OTA's Publishing Office (224-8996) for availability and ordering information.

Case Study #13

Cardiac Radionuclide Imaging and Cost Effectiveness

William B. Stason, M. D., S.M.
Associate Professor of Health Policy and Management
Center for the Analysis of Health Practices
Harvard School of Public Health

and
Director of Health Services Research
VA Outpatient Clinic
Boston, Mass.

Eric Fortess, M. P. H., S.M.
Center for the Analysis of Health Practices
Harvard School of Public Health
Boston, Mass.

AUTHORS' ACKNOWLEDGMENTS

The authors wish to thank the many physician experts and users of radionuclide imaging and employees of the companies cited in this case study for the information they provided through interviews and questionnaires. We also thank Helen Oskin, Leslie Stein, and Laurie Pearlman for their expert assistance in manuscript preparation.

Contents

	Page
Summary	3
Cardiac Radionuclide Imaging—A New Technology in Need of Scrutiny	4
The Technology—Past, Present, and Future	5
Past	5
Present	5
Future	10
The Market and the Industry	12
The Market	12
The Industry	12
The Producers	13
Users and Uses	15
Data Sources	15
Users	15
Clinical Indications	15
Potential Target Populations for Cardiac Imaging	17
Potential Demand for Cardiac Imaging	18
Costs and Charges	19
Costs of a Radionuclide Laboratory	19
Unit Costs of Cardiac Imaging Procedures	23
Current Charges for Cardiac Imaging Procedures	25
Clinical Efficacy	27
Medical Literature: Overview	27
Diagnostic Information	28
Cardiac Imaging Procedures: Review of the Medical Literature	30
Technical Challenges and Interobserver Variability	37
Potential Risks From Cardiac Imaging	37
Cost-Effectiveness Analysis	39
Framework for Analysis	39
Cost Effectiveness of Cardiac Radionuclide Imaging	41
Policy Implications	47
Appendix A.—Glossary of Terms	48
Appendix B.—Manufacturers of Cardiac Radionuclide Imaging Equipment and Supplies	49
References	56

LIST OF TABLES

<i>Table No.</i>	<i>Page</i>
1. Cardiac Radionuclide Imaging Techniques	7
2. Estimated Markets for Nuclear Imaging Equipment	12
3. Ranks and Market Shares of Producers of Nuclear Imaging Equipment	14
4. Clinical Indications for Cardiac Radionuclide Imaging	16
5. Deaths From Coronary Artery Disease, 1970-77	17
6. Death Rates From Coronary Artery Disease, 1970-77	17
7. Prevalence and Morbidity Data for Coronary Artery Disease, 1972	18
8. Hospital Discharges for Coronary Artery Disease, 1969-77	18
9. Projected "Demand" for Cardiac Imaging	19

<i>Table No.</i>	<i>Page</i>
10. List Prices of Selected Equipment Suitable for Cardiac Radionuclide Imaging	20
11. Estimated Annual Fixed Costs of Operating a Radionuclide Imaging Laboratory	21
12. List Prices of Radionuclides and Cold Product Kits	22
13. Production Capacity for Cardiac Imaging Procedures	23
14. Personnel Time Required for Different Cardiac Imaging Procedures and Estimated Cost Equivalents	24
15. Unit Costs of Cardiac Imaging Procedures Assuming Maximal Production Efficiency	24
16. Suggested Fee Schedules for Cardiac Imaging Procedures	26
17. Breakeven Points for Laboratory Operation	26
18. Thallium-201 Perfusion Scans in the Diagnosis of Coronary Artery Disease	32
19. Technetium-99m Radionuclide Angiography in the Diagnosis of Coronary Artery Disease	33
20. Technetium-99m Stannous Pyrophosphate and Thallium-201 Perfusion Scans in the Diagnosis of Acute Myocardial Infarction	35
21. Thallium-201 Perfusion Scans in the Evaluation of Coronary Artery Bypass Surgery Results	36
22. Technetium-99m Pyrophosphate Scans in Patients Who Have Had Coronary Artery Bypass Surgery	37
23. Radiation Exposure From Cardiac Radionuclide Imaging and Selected Radiodiagnostic Procedures	38
24. Effectiveness of Alternative Strategies Employing Cardiac Imaging and Exercise Tolerance Testing To Diagnose Surgically Treatable Coronary Artery Disease	43
25. Costs of Alternative Strategies to Diagnose Surgically Treatable Coronary Disease	44
26. Costs and Effectiveness of Alternative Strategies To Diagnose Surgically Treatable Coronary Disease	44
27. Cost Effectiveness of Alternative Diagnostic Strategies	45
28. Cost-Effectiveness Comparisons Between Alternative Diagnostic Strategies	45
29. Costs and Effectiveness of Alternative Strategies Employing Cardiac Imaging To Diagnose Surgically Treatable Coronary Artery Disease in Population Subgroups	46
30. Cost-Effectiveness Comparisons Across Population Subgroups	46

FIGURE

<i>Figure No.</i>	<i>Page</i>
1. Schematic Diagram of a Radionuclide Imaging System	6

Case Study #13: Cardiac Radionuclide Imaging and Cost Effectiveness

William B. Stason, M. D., S.M.
Associate Professor of Health Policy and Management
Center for the Analysis of Health Practices
Harvard School of Public Health
and
Director of Health Services Research
VA Outpatient Clinic
Boston, Mass.

Eric Fortess, M. P. H., S.M.
Center for the Analysis of Health Practices
Harvard School of Public Health
Boston, Mass.

SUMMARY

Cardiac radionuclide imaging is a new and rapidly expanding diagnostic technology that promises to make significant contributions to the diagnosis and management of heart disease. Dynamic changes are occurring in the technology at the same time diffusion is taking place. The combination of diffusion and technological development creates an imperative for careful evaluation and prospective planning.

Clinical applications of cardiac imaging include the diagnosis of coronary artery disease, evaluation of cardiac function abnormalities, verification of the diagnosis of acute myocardial infarction (heart attack), and monitoring of patients under treatment for establishing cardiac disease. * In 1978, an estimated 227,000 cardiac scans were performed, and expenditures for nuclear imaging equipment and radionuclides were \$225 million. About \$100 million of these expenditures can be ascribed to cardiac imaging. Projected figures for 1981 are for 1.5 million cardiac scans and total of about \$425 million. The potential target population for cardiac imaging

in the United States includes 12 million persons with suspected or established coronary artery disease and an additional 80 million asymptomatic adults 40 years of age or older who might become candidates for coronary disease screening programs.

The nuclear imaging equipment industry is highly competitive. The same is generally true of the radiopharmaceutical industry, the exception being the existence of a virtual monopoly for the production of one widely used radioisotope (thallium-201).

Capital costs to establish a radionuclide laboratory range from \$100,000 to well over \$500,000. Certificate-of-need determination can be avoided by establishing a laboratory stepwise, and it is doubtful whether the "new service" rule would apply. The resource costs of individual scanning procedures range from \$72 to \$258; recommended charges range from \$155 to \$405. This apparent discrepancy between costs and charges deserves further exploration.

The efficacy of cardiac imaging techniques in identifying physiologically significant coronary disease appears to be at least equal to, and prob-

*Definitions of some of the medical terms used in this case study are provided in app. A.

ably greater than, the efficacy of the exercise tolerance test. Furthermore, for assessing ventricular function, the radionuclide ventriculogram is comparable to the more invasive ventricular angiogram.

Before imaging techniques are widely applied to individuals with suspected or established cardiac disease, however, several important questions need to be answered. First, their performance in nonselected populations needs to be determined. Most studies to date have been done in patients with significant heart disease referred for cardiac catheterization. In patients who have minimal or no symptoms, sensitivities and specificities may well be lower. Second, the effectiveness and safety of imaging techniques when used in everyday practice by physicians need to be evaluated. It is not at all certain that results obtainable by the experts who publish their results

will be obtainable by average physicians. Third, important questions remain about how information from these tests will be used to benefit the patient. Test information is of little value unless it leads to better treatment decisions. Finally, important policy questions arise over utilization and quality control, reimbursement, and future research priorities. What means, if any, should be implemented to avoid excessive utilization? How can quality control, including avoidance of radiation hazards, be maintained in the face of rapid diffusion? Should standard policies concerning reimbursement be developed, and could these policies be used to influence utilization? To what extent should the further development of existing and new technologies be encouraged? All of these questions deserve careful examination by the medical profession and by the Federal Government.

CARDIAC RADIONUCLIDE IMAGING—A NEW TECHNOLOGY IN NEED OF SCRUTINY

Cardiac radionuclide imaging encompasses a variety of techniques designed to provide information of value in detecting the presence and extent of cardiac disease. All of these techniques are noninvasive and relatively risk free. All entail the injection of a radiopharmaceutical, its distribution to the myocardium (heart muscle) or throughout the blood pool, and the external detection of radioactivity by means of a gamma scintillation camera. Cardiac radionuclide imaging techniques represent additions to the cardiologist's already extensive diagnostic armamentarium, which includes the medical history and physical examination, resting electrocardiogram (EKG), chest X-ray, exercise tolerance test, echocardiography, and cardiac catheterization with coronary angiography.

The ultimate value of cardiac radionuclide imaging will have to be evaluated in terms of the information the technology can provide to the diagnosis and treatment of patients with heart disease. Questions of cost, long-term risks of low-level radiation exposure, and the ability of

radionuclide techniques to substitute for existing diagnostic modalities all need to be examined.

Why is evaluation of this technology important and timely? First, cardiac radionuclide imaging is experiencing an extraordinary rapid diffusion. An estimated 227,000 cardiac scans were performed in 1978, and 1.5 million scans were projected for 1981 (21). Commensurate growth is occurring in the domestic market for radionuclide imaging equipment and radiopharmaceuticals. In 1978, this market was \$225 million. It was estimated that by 1981, with a projected annual growth rate of 25 percent, the market would reach \$425 million. Cardiac imaging provides by far the major impetus for this growth.

Second, diffusion of this technology is occurring at a time when the virtues and limitations of the various radionuclide imaging procedures have been evaluated only in highly selected patient populations. Major questions remain to be answered. For example, are current estimates of

the sensitivity and specificity of these tests obtained in patients referred for cardiac catheterization applicable to asymptomatic patients being screened for possible coronary disease? Can private practitioners duplicate the results obtained by experts in tertiary medical centers? What is the most appropriate diagnostic strategy for each set of diagnostic challenges?

Third, technological change within radionuclide imaging is proceeding at a dizzying pace, both through improvements in existing techniques and through the development of new techniques that promise to provide information at the level of cellular function, as well as at the level of organ perfusion and function. Today's technology is sure to be outdated tomorrow, and evaluations done today may quickly become outdated. Ongoing monitoring of the technology will be essential.

Finally, the potential target population for cardiac radionuclide imaging, in the extreme, could include 80 million Americans over the age of 40. Cardiac imaging could, conceivably, replace the EKG as the baseline technique for evaluating the heart. Implications for the cost of diagnostic services and for the identification of increased numbers of patients who then would

be offered medical or surgical treatment are enormous.

There is little question that cardiac radionuclide imaging will play an increasingly important role in the diagnosis of heart disease. The challenge is to define that role in a way that maximizes benefits while controlling risks and costs.

In the next part of this case study, we describe the dimensions of the technology of cardiac radionuclide imaging. In the four parts that follow, we summarize information on the industry producing radionuclide imaging equipment, on clinical applications of technology, and on the costs and efficacies of the various techniques. Finally, we present our formulation of some of the issues involved in the assessment of the technology's cost effectiveness. Information for this case study was obtained from a variety of sources: from a review of the medical literature, from interviews with industry representatives, and from experts and users of the technology. Our ambitions have far exceeded our resources in performing this study. Though we believe the information presented to be reliable, we acknowledge that in some respects the report is less than complete.

THE TECHNOLOGY—PAST, PRESENT, AND FUTURE

Past

Radioactive tracers were first used to study the heart in 1927, by Blumgart and Weiss. These investigators used radium as the tracer and a cloud chamber as a detector (s). In 1954, accumulation of radioactive potassium and its analogs in the myocardium was demonstrated (37), and in 1962, rubidium and cesium were applied in myocardial imaging (16). Since that time, a number of radionuclides and a variety of techniques have been developed.

Present

General Description of the Technology

Required components for cardiac radionuclide imaging include a radiopharmaceutical (usually

a gamma emitter), a detector, photomultiplier tubes and amplifiers, a cathode ray tube for visualizing the image of the heart, and a computer system to permit storage and analysis of acquired count information. Figure 1 depicts these components schematically.

In a typical study, a radiopharmaceutical is injected into a resting or exercising patient and distributed to the heart and other tissues according to its chemical and physical characteristics. Gamma radiation emitted by the radionuclide is detected externally by either: 1) a scintillation probe; 2) a rectilinear scanner; or 3) a scintillation camera. For all three detector types, the operating principle is the same. A photon of gamma radiation enters the detector and collides with one or more crystals of sodium iodide. This

Figure 1 .-Schematic Diagram of a Radionuclide Imaging System

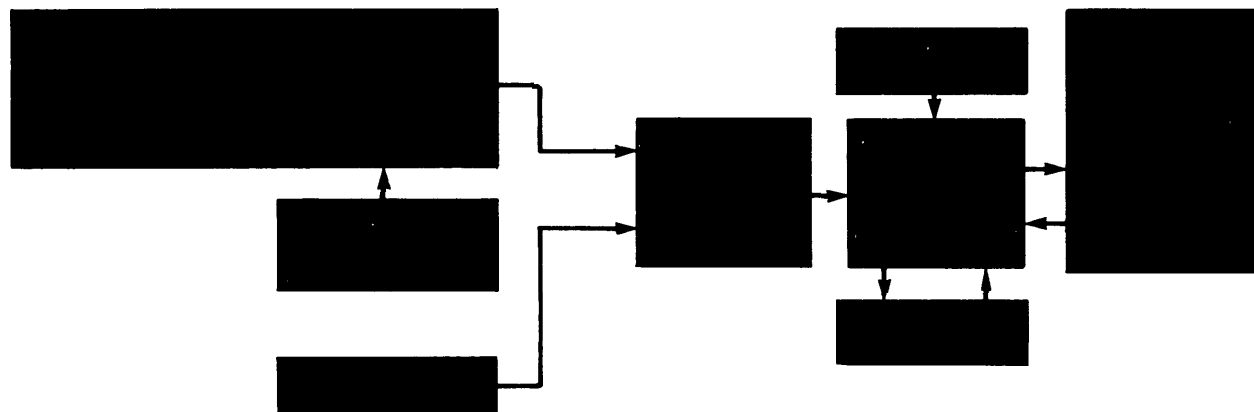

collision causes a tiny flash of light which is sensed by a photomultiplier tube and converted to an electronic signal. The electronic signal, in turn, passes to amplifiers and through logic electronics which determine the point of origin within the patient's body. The readout device displays an image of the heart constructed from many thousands of these radiation photons, or "counts." This image can be preserved on film or by feeding the count data to a computer for mathematical manipulation, analysis, and storage on a magnetic tape or disk.

The three classes of detectors—scintillation probes, rectilinear scanners, and scintillation cameras—vary in sensitivity to gamma emissions and ability to achieve spatial resolution. The tradeoff between sensitivity and resolution for any given gamma detector can be adjusted by use of different collimators. (A collimator, basically, is a device used to control the incoming gamma photons, very much in the same way that the aperture is used to control the amount of light entering a camera. It will decrease the sensitivity of the detector by decreasing the number of photons that are permitted to reach the sodium iodide crystal. At the same time, however, the origin of the photons that do pass through can be more accurately localized within the body.) The scintillation probe is usually used with a flat field collimator which provides very high sensitivity to photons anywhere within its field of view. The rectilinear scanner uses a

focused collimator, which lowers sensitivity. The scintillation camera is the least sensitive of the three detectors, but does offer the best spatial resolution. With or without a computer, this is the most commonly used detector for cardiac radionuclide studies.

Imaging Techniques

Table 1 summarizes the currently available imaging techniques and indicates the types of information each provides. These techniques are described below.

Thallium-201 (Tl-201) Perfusion Images.—Thallium chloride (Tl-201) is a radionuclide that, when injected intravenously, behaves as an analog of potassium. It has a half-life of 74 hours and must be generated by a cyclotron or linear accelerator. Initial distribution within the body is related to regional perfusion and to the cellular extraction efficiency of the various organs. The myocardium (heart muscle) has a very high extraction efficiency (**85 percent**). Thus, initial distribution is very closely related to blood flow. Areas of the myocardium that are well perfused will have a high concentration of thallium ion, while areas that are less well perfused will have lower concentrations. It is this relation of accumulation to perfusion that provides the clinical utility of cardiac radionuclide imaging with thallium. Thallium images can be performed at rest or during exercise as separate

Table 1.—Cardiac Radionuclide Imaging Techniques

Technique	Information content	Identifies
<i>Thallium (TI-201) perfusion studies</i>		
Resting	Perfusion defects at rest	Severe ischemia at rest Old or recent infarct
Exercise	Perfusion defects under stress	Transient ischemia Old or recent infarct
Rest-exercise (2-dose)	Both of the above	Differentiate transient ischemia from infarct
Exercise-redistribution	Both of the above	Same as rest-exercise
Technetium (Tc-99m) ventriculographic studies		
First-pass: resting and exercise	Blood transit times Ejection fraction Chamber volumes Wall motion	Ventricular function abnormalities Wall motion abnormalities Ventricular aneurysms Valvular regurgitation Intracardiac shunts
Multiple-gated acquisition (MUGA): resting and exercise	Same	Same except shunts not identifiable
Infarct ("hot spot") imaging	Acutely damaged myocardium	Acute myocardial infarction (after 24 hours)
Tomographic methods		
Single-photon emission tomography		
Single-photon gated blood pool tomography		
Positron emission transaxial tomography (PETT)		
Computed axial tomography (CAT)		

studies, or in combination in so-called exercise-redistribution studies.

In a resting study, the patient is injected with 1 to 2 mCi of thallium, and 10 to 15 minutes later, counting is begun. Two or three separate views are obtained with the camera in different positions relative to the heart, each requiring 10 to 15 minutes counting time to obtain a high-quality image. Perfusion "defects" on images taken with the patient at rest represent areas of myocardial damage (old or recent infarctions) or severe ischemia.

Exercise is usually required, however, to induce the transient ischemia that has its clinical equivalent in angina pectoris. In an exercise study, the thallium dose is injected during stress, and the image is obtained immediately thereafter. The stress is provided by exercise on a bicycle ergometer or treadmill or by pharmacological means with a vasodilator (e.g., dipyridamole). A disadvantage of obtaining an exercise thallium scan alone is that no distinction can be made between perfusion defects caused by infarction from those due to transient ischemia. Comparison of the rest and exercise images, on the other hand, helps make this distinction between fixed and transient defects. A patient with

transient ischemia will have a normal resting scan but show detectable defects on the exercise scan. A patient with a myocardial infarction will show a defect on the resting scan and show new or enlarged defects with exercise if transient ischemia is produced.

The exercise-redistribution study allows one to obtain both rest and exercise information with a single dose of thallium. The patient is exercised, injected with thallium, and scanned as in an exercise study. Two to four hours later, a second image is obtained (without further administration of thallium) while the patient is at rest. A patient with transient ischemia will show defects on the exercise image but reduced or no defects after "redistribution" occurs. A patient with infarcted tissue only will show similar defects on both images. The physiologic explanation for the redistribution of thallium is not completely understood, but may relate to residual thallium activity in the blood, greater cellular extraction of thallium by ischemic tissue as the ischemia resolves during rest, and/or to decreased loss of thallium from the ischemic area.

Technetium (Tc99m) Studies.—Technetium is used in combination with a variety of chemical

and physiological substrates to assess cardiac function abnormalities. It is marketed in the form of a molybdenum technetium generator, containing molybdenum-99m on an alumina column; technetium-99m is eluted when sterile saline is passed through the column. Molybdenum has a half-life of 67 hours, requiring weekly replacement of the generator, and the eluted technetium has a half-life of only 6 hours. The radionuclide may also be supplied as "instant technetium," which must be delivered daily.

Unlike thallium, which is injected directly as the chloride salt, technetium must be used in conjunction with a "cold mix" or "cold imaging agent"—a compound whose biological behavior in the patient's body will cause the radionuclide to be carried to the desired organ sites. In the case of cardiac studies, the "cold mix" causes the technetium to become attached to red blood cells or albumin and hence to remain in the blood pool.

Technetium studies assess cardiac function and infer from observed abnormalities the underlying cause and extent of disease. Parameters measured include global and regional ejection fractions (the amount of blood ejected during a heart beat), abnormalities in myocardial contractility (wall motion abnormalities), cardiac output and transit times, and the presence of intracardiac shunts. Studies may be performed during exercise to uncover abnormalities not present at rest. At rest, for example, a patient's ejection fraction may be normal; during exercise, though, a normal person's ejection fraction will rise, while that of a person with heart disease may remain unchanged or even fall.

As a group, the technetium studies discussed below require much more sophisticated computer and software capabilities than do thallium studies.

First-pass studies.—In 1969, Mullins demonstrated the passage of a radionuclide through the heart synchronized with an EKG. Counts from several cycles at end-diastole and several at end-systole were summed, and the resultant images were used to calculate heart chamber volumes (49). More recently, methods have been developed to calculate ejection fraction directly from

the count activity in the chambers using a multicrystal scintillation camera and a computer (11,68,75,87).

A first-pass study is performed by rapidly injecting a small bolus of technetium-labeled imaging agent (technetium pertechnetate) and scanning the patient as this material passes through the heart. Because only the first passage of the radionuclide through the heart is recorded, scanning can be performed in as little time as 1 minute. Several complete cardiac cycles are summed to create a "typical" cycle with enough counts to produce a well-resolved image. Both right and left ventricles can be evaluated from separate activity curves. If, in addition, the regional wall motion of the ventricles is to be assessed for abnormalities in contraction, multiple views of the heart may be required. The brief duration of the first-pass study allows only one viewing angle per injection. Thus, a second or even third injection of radionuclide is required to obtain the additional views. These can be obtained readily at a single sitting, however, because technetium pertechnetate is rapidly cleared from the blood pool.

Multiple-gated acquisition (MUGA) studies.—Instead of gathering data on the first pass of technetium through the heart, a MUGA study measures activity of the radionuclide after it has equilibrated in the pool of circulating blood. The word "gated" refers to the synchronization of the scintillation camera computer system with the R wave of EKG. Counts obtained during different phases of the cardiac cycle are summed over many beats, permitting generation of a high-resolution image of a moving organ. The same measures of cardiac function are calculated in MUGA studies as in first-pass studies, except that intracardiac shunts cannot be derived.

The MUGA study technique requires the patient to be injected with pyrophosphate, followed 15 minutes later by a saline solution containing 20 to 25 mCi of technetium-99m. One or more views are then obtained, depending on the purpose of the study; each view requires 5 to 10 minutes of counting time. With appropriate instructions for "area of interest" determination and background subtraction, the computer cal-

culates desired measurements. In addition, the data from summed "representative" beats can be played as a motion picture of the contracting heart to estimate wall motion abnormalities. Again, studies can be done at rest and during exercise to examine the effect of stress on ejection fraction and regional wall motion.

Infarct ("hot spot") imaging.—This technique depends on the affinity of certain substances for recently damaged areas of myocardium and can be used to facilitate the diagnosis of acute myocardial infarction. Mercury-203-labeled chlormeridin (17), Tc-99m tetracycline (40), and, most recently, Tc-99m pyrophosphate (29) have all been used for this purpose.

The radiopharmaceutical is injected, and scanning is performed 2 to 3 hours later. Both the location and area of an infarct can be estimated. For maximal sensitivity, scans should be performed at least 24 hours after an infarction. The major applications of the technique appear to be to provide information useful to guide treatment decisions in patients admitted with suspected myocardial infarctions (e. g., early transfer from the coronary care unit).

Tomographic Methods.—The studies discussed to this point provide data in a two-dimensional format. Tomographic methods, discussed briefly below, address the need for a three-dimensional perspective.

The output of tomographic methods is a set of "slices" through the volume of the heart. If a thread were drawn vertically from top to bottom of the heart through the center of its volume to form an "axis," the tomograph would produce slices perpendicular to this axis (hence the derivation of the adjective "transaxial"). Each slice is rotated 90° to place it in the plane of the screen or photograph, and ordered so that the viewer is able to examine contiguous cross-sections of the heart.

The tomographic methods discussed briefly below are: 1) techniques using single-photon gamma radiation emitters; 2) a technique using a two-photon emitter called positron emission tomography; and 3) an X-ray technique, computed-axial tomography (CAT) scanning. In

general, these techniques either have had less extensive clinical evaluations than the perfusion and blood pool studies described above or are in experimental phases. They are important, however, because they represent probable future directions for the technology.

Single-photon emission tomography.—There are two variants of this. One method uses a multiple-pinhole collimator in conjunction with a standard single-crystal gamma camera to obtain tomograms of the heart. With this technique, using thallium as the radionuclide, greatly increased sensitivity in detecting significant coronary artery obstruction has been reported (80).

The second variant employs a "radionuclide body function imager" which has 10 detectors mounted on ring-shaped gantry into which the patient is placed. The multiple-detector array permits rapid imaging (20 to 30 minutes for a complete set of images). Early results suggest that this technique, again using thallium-201, produces images superior to those of nontomographic techniques (32).

Single-photon gated blood pool tomography with technetium is in an early stage of development, but appears to have considerable potential.

Positron emission tomography.—Double-photon emission tomography, or positron-emission transaxial tomography (PETT), uses radionuclides characterized by a short half-life, which emit positrons or anti-electrons. When a positron combines with an electron in its immediate environment, "annihilation" occurs, and a pair of gamma rays is generated, each of which travels outward from the origin in an opposite direction from the other. Very accurate localization is achieved by "coincidence counting" on two detector plates 180° apart. Only those events that produce gamma rays that strike both detectors at the same time are counted and used to build up tomographic images. Radionuclides are incorporated into biologically active elements and compounds, which can then be used to evaluate myocardial perfusion and metabolism. Carbon-*n*-labeled palmitate, a physiological substrate of the myocardium, for example, can

be used to image infarcts as tomographic “cold spots” (72), and nitrogen-13-labeled ammonia has been reported as highly sensitive to perfusion abnormalities (25).

The half-lives of positron-emitting radiopharmaceuticals are extremely short: 2 minutes for oxygen-15, 10 minutes for nitrogen-13, and 20 minutes for carbon-11. These short half-lives greatly reduce the radiation dose to the patient and allow repeat scans in the same patient every 20 to 30 minutes. However, they require that centers performing positron scanning have on-site access to a cyclotron, which is required to produce most of the radio-labeled compounds.

The first two operational PETT instruments were installed in 1974, one at the Massachusetts General Hospital in Boston and one at Washington University in St. Louis, Mo. Since then, between 12 and 20 centers in the United States have acquired units. All of these are used primarily in research activities.

Computed-axial tomography (CAT).—CAT scanning is a radiologic rather than a radionuclide method. The scanner rotates about the patient’s body to produce a tomographic slice that is based on the varying X-ray densities of the body organs and their components. Recent technologic improvements have reduced required scanning times to fractions of seconds and permitted electrocardiographic gating for longer duration CAT scanning of the heart. Efforts to detect and size infarcts thus far have indicated that CAT scanning tends to underestimate the size of infarcts (27,70). Concomitant use of contrast material may improve resolution. However, a device called the dynamic spatial reconstructor, recently installed at the Mayo Clinic, permits a slice to be obtained in one-hundredth of a second and creates the potential for much more sophisticated studies. The dynamic spatial reconstructor was built at a cost of about \$3 million.

The existence in the United States of over 1,100 CAT scanners suggests that there will be ample incentive to press forward with cardiac applications.

Future

Future development of cardiac radionuclide imaging will involve improvements in each of the components of present scanning systems—the camera, the computer, and the radionuclide. In addition, positron emission tomography, single-photon emission tomography, and CAT scanning undoubtedly will undergo further technological development and extensive clinical evaluations.

Camera

Improved counting efficiency and the resulting improved spatial resolution are major goals. At present, only the multicrystal camera has a counting efficiency sufficient for good resolution on first-pass studies. The more commonly used single-crystal (Anger) camera, with an efficiency of only 1 percent (50,000 to 100,000 counts per second), has proven very marginal on first-pass studies. Changes in the camera, coupled with the application of multiple-aperture pinhole tomography, may help to resolve these deficiencies. The possibility of new types of detectors, such as those having a digital solid-state design, is also being explored.

Computer Hardware and Software

The development of computers will continue to follow two divergent trends. One trend is toward large central processing units capable of accumulating, manipulating, and storing large amounts of data. The other is toward small remote computers, coupled with a scintillation camera, for data acquisition and limited manipulation or input into a central processing unit. Computers will increase in specialization, become more operator-oriented, and require less technical knowledge to operate. The trend toward more expensive installations will be fostered by the desire for greater capability to do highly sophisticated quantitative studies, while the impetus toward development of small, easy-to-operate units will be led by industry’s interest in cultivating the broader market represented by physicians’ offices and community hospitals.

Progress is being and will continue to be made in improving the software packages needed for cardiac radionuclide studies. Similarly, the quantification and successful application of the radioisotopic tomographic techniques and gated CAT scanning will depend on the development of highly sophisticated computer algorithms. Better methods for background subtraction, count smoothing, color images keyed to count density, automatic chamber border definition, and arrhythmia discarding are among the features that are being developed.

Radionuclides

An ideal radionuclide would have the following properties:

- gamma photon energy in the 100 to 300 KeV range to minimize attenuation by surrounding tissue;
- absence of beta or beta-like radiation;
- a physical half-life ($T_{1/2}$) of 1 to 30 minutes to permit multiple views with a single injection, while minimizing the total radiation dose;
- generator systems (similar to technetium) having long-lived parent elements to obviate the need for onsite cyclotrons or linear accelerators;
- a high target-organ-to-background ratio; and
- low cost and wide availability.

No ideal isotope currently exists, but several possibilities are being investigated. Among these are germanium (parent) -gallium ($T_{1/2} = 1$ hour) and strontium ($T_{1/2} = 25$ days)-rubidium ⁸² ($T_{1/2} = 75$ seconds).

Emerging Technologies

The technetium gated blood pool (MUGA) study will improve in sensitivity, specificity, and information content. Advocates believe that MUGA studies may supplant the standard thallium perfusion studies on the basis of their greater information content, less expensive radionu-

clide, and reduced patient radiation dose. Thallium perfusion study advocates do not agree.

In the near future, single-photon tomographic methods will compete with radionuclide ventriculography and may well supplant standard perfusion techniques. It is not clear which of the two single-photon methods will have wider use. The seven-pinhole tomographic method is attractive, because it can be used with standard scintillation cameras and computers, with the addition of only a seven-pinhole collimator and software packages (available for about \$11,000). The software for gated blood pool tomography also is being developed. The revolving-head, single-photon tomographic imager may produce even better resolution than seven-pinhole tomography, but it is more expensive (current cost about \$400,000).

In the more distant future, PETT (positron-emission transaxial tomography) may play a large role in cardiac diagnosis because of its ability to provide information on cardiac structure, function, and metabolism. The requirements for an onsite cyclotron and for sophisticated hardware result in a startup cost of \$1.5 to \$2 million. The general opinion expressed by experts is that PETT's dissemination will be limited to selected tertiary medical centers. However, there is evidence that the size, cost, and complexity of the technology will be reduced. For example, a Japanese-produced "desk top" cyclotron and positron camera are being marketed by Atomic Energy of Canada in Montreal at a cost of about \$600,000 for the cyclotron and \$350,000 for the camera. If the trend toward lower cost continues, wider dissemination might be anticipated.

The CAT scanner recently installed at the Mayo Clinic—the dynamic spatial reconstructor (Raytheon)—has yet to be evaluated. Zeugmatography (nuclear magnetic resonance imaging) and Fourier multiaperture emission tomography (62) are also in early phases of evaluation. Each of these technologies merits careful monitoring.

THE MARKET AND THE INDUSTRY

The Market

Nuclear imaging is among the fastest growing areas in the marketplace for medical equipment. Within imaging, cardiac procedures lead the way as the major stimulus for growth. In 1978, it was estimated that 6.5 million nuclear studies were performed, of which 227,000 were of the cardiac system. Projections for 1981 were for a total of 9.7 million studies (12-percent annual growth rate), of which 1.5 million would be cardiac scans (71-percent annual growth rate) (21). *

The market for cardiac imaging equipment has been assessed traditionally in terms of the number of hospitals that have departments of nuclear medicine. At present, about half of the 7,100 hospitals in the United States have such departments. However, large hospitals probably constitute only a small part of the potential market; small community hospitals and independent physicians' practices are increasingly expressing interest in being able to perform radionuclide studies. A significant trend in the industry, in fact, has been to satisfy this burgeoning market with equipment that is smaller, simpler to operate, and less expensive.

The Industry

The industry can be divided into producers of: 1) gamma scintillation cameras; 2) computers; 3) radiopharmaceuticals; and 4) ancillary equipment used in conjunction with nuclear medicine systems. Table 2 summarizes estimated 1978 and projected 1981 and 1984 unit sales and dollar volumes for the first three of these market segments (21).

The fastest growing segment of the market is computer systems, where the major impetus for growth has been provided by the rapid increase in cardiac imaging. Nuclear medicine computer systems, consisting of a minicomputer or microprocessor, memory, storage, CRT display and/or CRT terminal, retail for \$50,000 to \$120,000 (1978 prices).

* Another projection, by Market Measures Inc. (1980), was for 650,000 to 830,000 cardiac scans in 1981.

Table 2.—Estimated Markets for Nuclear Imaging Equipment

Type of equipment	1978E ^a	1981 E	1984E
Scintillation cameras^b			
Number of units in service	8,000	9,500	11,000
Annual unit sales.	800	1,100	1,400
Annual dollar sales (millions).	\$85	\$150	\$225
Computer systems			
Number of units in service	1,000	2,200	4,000
Annual unit sales.	275	450	700
Annual dollar sales (millions).	\$20	\$40	\$70
Radiopharmaceuticals			
(millions) ^c			
Technetium sales.	\$35	\$45	—
Cold product kit sales.	40	80	—
Thallium sales.	7	35	—
Other sales.	38	75	—
Total (millions).	\$225	\$425	\$295

^aEstimates for 1978 by IMS, Inc (1979) differ substantially: technetium, \$30 million; cold product kits, \$18 million; thallium, \$7 million; and "other," \$23 million; corresponding estimates for 1981 are \$42 million, \$26 million, \$35 million, and \$30 million respectively.

^bIncludes rectilinear scanners.

SOURCE: F Eberstadt & Co., Inc., 1978.

The camera segment of the market is characterized by expansion in the number of medical facilities doing imaging, by the upgrading of existing equipment, and by expansion of existing nuclear medicine laboratories to include more than one camera/computer unit. Gamma scintillation cameras are being bought to replace rectilinear scanners, and large-field-of-view cameras (required for multiple-pin-hole tomography) are being bought to replace small-field-of-view cameras. Mobile gamma camera units are being bought to serve patients who cannot be transported conveniently to a central nuclear medicine facility (e. g., patients in emergency rooms, coronary care units, and operating or surgical intensive care units). The average price of a gamma camera in 1978 was \$100,000 to \$110,000.

New England Nuclear's introduction in December 1977 of thallium-201 for cardiac perfusion studies was perhaps the most significant development in the radiopharmaceutical industry. Of cardiac images done in 1978, nearly half used thallium. Because thallium perfusion studies do not require sophisticated computer software,

their growth in the short term will, in all likelihood, keep pace with or exceed the growth of MUGA technetium studies. With the rapid growth projected for cardiac images, the thallium market looks robust. Growth in the market for technetium and cold product kits probably will be less dramatic, because the frequency of brain scans using technetium is decreasing and because other uses of technetium outside cardiology are not rapidly expanding. Between thallium and technetium, there exists a considerable per-dose price differential. The list price for a 1.65 mCi dose of thallium was recently raised to over \$100, whereas comparable prices per dose of technetium are in the \$8 to \$10 range.

The Producers

Producers can be categorized as manufacturers of: 1) scintillation cameras and integrated systems; 2) computer hardware and software; and 3) radiopharmaceuticals. Rankings and estimates of percentage of market share of major producers are presented in table 3. Detailed descriptions of products, manufacturers' sales, strategies, and projected future directions are provided in appendix B.

Data Sources

Data on producers were collected for this case study from telephone and personal interviews with company executives (usually the director of marketing or technical director), from producers' brochures and annual reports, and from advertisements in professional and trade journals. Thus, the results presented below reflect our own interpretations of data from multiple sources and should not be taken to be official opinions of the firms concerned. Information was particularly difficult to obtain on sales and profits. Unfortunately, the annual reports of larger companies do not present sales information in sufficient detail to allow the extraction of information related to nuclear medicine equipment. The rankings of companies within an industry segment that are presented in this case study, therefore, reflect respondents' perceptions of national sales. Furthermore, it should be noted that large variations in sales patterns may occur between geographic regions. In the radio-

nuclide market, for example, almost all of the technetium used on the east coast is generator-produced by the three major generator manufacturers, while in California, a sizable number of users prefer "instant technetium" delivered daily by Medi + Physics and smaller radiopharmaceutical producers.

Major Findings

The nuclear medicine industry is a very competitive one, except in the thallium production segment. In the camera segment, the acknowledged leaders are Searle, Ohio Nuclear, Picker, and General Electric. The competition is sufficiently keen that the leader, Searle, allegedly lost several million dollars on its camera business in 1978. The mobile camera represents a major growth area. Here Ohio Nuclear, with its small, maneuverable, and reliable "Moon Buggy," is the acknowledged leader, having perhaps two-thirds of the market.

Analytical Development Associates Corp. (ADAC) Laboratories and Medical Data Systems appear to be the front runners in computer systems. ADAC's strategy is to promote sales of moderately priced units to small and middle-sized hospitals and to private physicians' offices. Twenty-five percent of sales in 1979 involved second units to hospitals. Medical Data Systems, on the other hand, though interested in the same market, takes pride in its more sophisticated hardware and software.

Competition among producers of technetium-99m and its associated cold product kits is at least as intense as that among producers of cameras and computers. Mallinckrodt, Squibb, and New England Nuclear are the leaders, each with its advocates and detractors. The possibility for generator production of the isotope from a long-lived parent, coupled with competitive pressure, keeps the price of radioisotope per study down. On the other hand, the only current producer of thallium is New England Nuclear, though Mallinckrodt has received the Food and Drug Administration's approval to sell in this country. It is difficult to predict how much effect Mallinckrodt's entry into the market will have on the future prices of thallium. Nor is it possible to

predict what effect New England Nuclear's linear accelerator will have when it comes on line and is used to produce thallium. Presumably, its

greater efficiency will permit a reduction in price.

Table 3.—Ranks and Market Shares of Producers of Nuclear Imaging Equipment^a

Market segment and company	Current survey						Comments
	1	2	3	4	5	6	
Scintillation cameras							
Searle Radiographic.	5		1	1			Searle = 1—50-60% ^b
Ohio Nuclear.		6	1				Ohio Nuclear = 2—20-25%
Picker.	2	2	3				Picker = 3
General Electric.		1	2				General Electric = 4
Raytheon.				1	2		
Baird Atomic.				1			
Union Carbide.				1	1		
Toshiba.							
Elscint.							
Pfizer.							
Computer systems							
ADAC Laboratories.	1	1					ADAC = 1—25-30% ^b
Medical Data Systems.		1	1				Medical Data Systems = 1—25-30%
Digital Equipment.	1				1		Digital Equipment = 3—15-200/o
Ohio Nuclear.			1		1		Ohio Nuclear = 4—10-150/o
Informatek.				1			1 Informatek = 5—5.10%
Searle Radiographic.				1			
Data General.							
Keronix.							
Radionuclides							
Thallium							
New England Nuclear.	1						New England Nuclear is sole source as of 1979. Mallinckrodt recently received FDA approval.
Mallinckrodt Nuclear.							
Technetium							
Mallinckrodt Nuclear.	4	1					Very competitive market
Squibb.	3	1		1			
New England Nuclear.	1	2	3				
Union Carbide.			1	2			
Medi + Physics.				1	2		
Cardiac cold mix							
Union Carbide.	1						
Squibb.		1					
Mallinckrodt Nuclear.			1				
New England Nuclear.				1			
Procter and Gamble.							
Ackerman Nuclear.							
Ancillaries							
Harshaw Chemical Co.							Small subset of the hundreds of companies involved. No ranks assigned.
Meal-X, inc.							
Eastman Kodak							

^aDetermined from interviews of company representatives. Each company interviewed was asked to rank producers in its market segment from 1 to 6. Some respondents awarded tie rankings. Others failed to rank all major producers. Example: Five persons ranked Searle first among producers of scintillation cameras and one each ranked it third and fourth.

^bMarket shares as reported by F. Eberstadt and Co., Inc., 1978.

USERS AND USES

Data Sources

Information on users and uses of cardiac radionuclide imaging was obtained for this case study from questionnaires distributed to selected institutions performing cardiac radionuclide imaging, from informal interviews with other physicians and technologists, from the medical literature (which primarily represents the opinions and practices of experts), and from health statistics prepared by the National Center for Health Statistics (NCHS). Projections of the potential utilization of imaging procedures, though based on the best available prevalence data, must be considered speculative, especially in the face of the rapid evolution that the technology is undergoing.

Users

Nearly all of the existing 3,500 departments of nuclear medicine in the United States now have the ability to perform one or more types of cardiac radionuclide imaging procedures. In these institutions, nuclear medicine experts are responsible for purchasing and maintaining hardware and test performance. Referrals come from cardiologists and internists, and only rarely are criteria to guide utilization specified.

Radionuclide imaging units are also being sold to hospitals without departments of nuclear medicine. These hospitals, through their departments of radiology or cardiology, represent major targets of the industry's promotional efforts. Similarly, group practices and private physicians are acquiring the capability to perform scans. The extent of penetration into these markets is difficult to quantify at the present time.

Of the nonrandom sample of 13 institutions we surveyed, 7 were tertiary medical centers and 6 were community hospitals. Of the seven referral centers, five favored technetium studies over thallium studies (all performed both, however); four had multicrystal cameras capable of performing first-pass studies; five had both mobile and stationary scintillation cameras; and the average number of cameras owned was 2.6. In

the six community hospitals, thallium perfusion studies predominated. Only two had the computer hardware capable of performing MUGA technetium studies, and three had mobile camera units.

The estimated number of cardiac studies performed in the 13 institutions surveyed ranged from 3 per week in one community hospital to over 50 per week in two tertiary centers. Rest and exercise studies were about equally represented. In the community hospitals, cardiac images, on average, constituted about 30 percent of all radionuclide studies performed. In the referral centers, there was a greater tendency for some equipment to be totally dedicated to cardiac uses.

Each institution surveyed indicated more or less well-defined plans for updating or enlarging its capability to perform cardiac studies within the next year or two. Referral centers indicated particular interest in tomographic techniques (single-photon emission tomography and gated CAT scanning) and in positron emission tomography. Several of the community hospitals interviewed favored seven-pinhole tomography.

Experts in cardiac radionuclide imaging appear to divide themselves into three groups: advocates of first-pass or MUGA technetium studies; equally vociferous defenders of thallium perfusion studies; and those who believe that these two types of studies are complementary, each contributing valuable independent information. Advocates of technetium studies point to their greater information content (cardiac output, ejection fractions, transit times, in addition to wall motion abnormalities), while perfusion study supporters believe that this type of imaging is more sensitive in detecting coronary artery disease.

Clinical Indications

Clinical indications for cardiac radionuclide imaging cover the entire spectrum of cardiac disease. At one end, some experts point to the technology's potential for routine screening for coro-

nary disease in asymptomatic individuals. In this case, it might supplement or substitute for the routine resting EKG. At the other end of the spectrum, cardiac radionuclide imaging is used to monitor the effects of drug therapy or surgery in patients with established heart disease. In between are the applications most widely reported in the medical literature: evaluation of suspected coronary disease (e. g., chest pain of uncertain cause); determination of the extent of disease prior to coronary angiography or surgery in patients with established disease; and the diagnosis of acute myocardial infarction. Table 4 lists major indications, the type of test used for each indication, the type of information yielded, and the potential action(s) to be taken if the test result is abnormal.

We were unable to obtain any information to quantify the extent to which cardiac radionuclide imaging is being used as a primary screening procedure. Furthermore, no information is available in the medical literature to document the sensitivity and specificity of scanning in unselected asymptomatic patients. In the absence of data, the implications of a widespread policy to screen such individuals can only be speculated upon.

In patients with established coronary disease, imaging procedures at present appear to be used primarily as adjuncts to other diagnostic tests, especially exercise tolerance tests and coronary angiography. A substitutive role has yet to be defined. Some cardiologists believe that some

Table 4.—Clinical Indications for Cardiac Radionuclide Imaging

Indication	Test	Derived information	Actions
Screening for CAD in asymptomatic patient	Tl-201 (R &/or E) First-pass or MUGA (R &/or E)	Perfusion defect Wall motion or EF abnormality	ETT Coronary angiography
Suspected CAD • asymptomatic with positive ETT • chest pain, ? etiology • abnormal EKG precluding ETT	Same as above	Same as above	Coronary angiography
Probable or definite angina pectoris	Tl-201 (R & E or E-R) MUGA or first-pass (R &/or E)	Perfusion defects Wall motion or EF abnormality	Coronary angiography
Suspected acute MI • within 24 hr • 24-72 hr	Tl-201 or MUGA (R) Tc-99m pyrophosphate ("Hot spot")	Same as above Identify extent & location of MI	Admit to CCU? Continue in CCU?
Recovery from MI	Tl-201 (R & E or E-R) MUGA or first-pass (R & E)	Perfusion defect(s) enlarge with exercise Wall motion or EF abnormality	Activity prescription Coronary angiography
Congestive heart failure	MUGA or first-pass (R &/or E)	Wall motion or EF abnormality	Surgery for left ventricular aneurysm?
Patients undergoing CABS	Tl-201 (R & E or E-R) MUGA or first-pass (R & E)	Response to surgery	Activity prescription Adjust medical therapy
Monitor drug therapy (nitroglycerin, propranolol, adriamycin, etc.)	Tl-201 (R & E or E-R) MUGA or first-pass (R+ E)	Extent of perfusion defects Wall motion or EF abnormalities	Adjust medical therapy
Congenital heart disease—shunts	First-pass (R &/or E)	Quantification of shunts	Cardiac catheterization
Valvular insufficiency	First-pass or MUGA (R &/or E)	Valve regurgitation	Cardiac catheterization

CAD = coronary artery disease
ETT = exercise tolerance test
EKG = electrocardiogram
MI = myocardial infarction
CABS = coronary artery bypass surgery
CHF = congestive heart failure

Tc-99m = technetium perfusion study
Tl-201 = thallium perfusion study
first-pass = first-pass technetium study
MUGA = multiple-gated acquisition technetium study
R = rest
E = exercise

E-R = exercise redistribution
ETT = exercise tolerance test
EF = cardiac ejection fraction
CCU = coronary care unit

coronary angiographies will be avoided by normal or minimally abnormal radionuclide studies in patients with chest pain syndromes. Others point to the potential of radionuclide studies to obviate the need for coronary angiography in patients with congestive heart failure who have findings that would not be amenable to surgery (e.g., diffuse myocardial contraction abnormalities).

In the only systematic study of the role played by cardiac imaging in physician decisionmaking, 58 percent of 171 consecutive studies met established criteria for ordering, usefulness, and interpretation, but only 12 percent were considered to contribute to appropriate changes in therapy (24). Clearly, much remains to be learned of the real contribution that cardiac radionuclide imaging can make to the clinical management of patients with heart disease.

Potential Target Populations for Cardiac Imaging

Selected statistics will provide a framework for speculation regarding the ultimate extent of

diffusion of cardiac radionuclide imaging. We summarize current information on heart disease mortality and morbidity below. Then we present implications of these data for the potential number of studies that might be performed under different assumptions.

Heart disease constitutes the leading cause of mortality and morbidity in the United States. In 1977, it killed almost 719,000 Americans, with 638,000 dying as a result of ischemic heart disease (50). An additional 1,465,000 hospital discharges were attributed to ischemic heart disease (59). By comparison, cancer, the second leading cause of death, resulted in 377,000 deaths (1976 data (60)). Mortality data for ICDA codes related to coronary artery disease, presented in tables 5 and 6, show that the number of deaths and age-adjusted mortality rates from all heart diseases and from acute myocardial infarction decreased between 1970 and 1977. During this same period, death rates from chronic ischemic heart disease failed to show any clear trend.

Morbidity data provide further documentation of the enormous impact of coronary artery

Table 5.—Deaths From Coronary Artery Disease, 1970-77

ICDA code ^a	1970	1971	1972	1973	1974	1975	1976	1977
410-413 Ischemic heart disease.	666,665	674,242	684,424	684,066	664,854	642,719	696,673	638,427
410 Acute MI	357,241	357,714	357,844	351,662	334,196	324,652	319,477	306,398
411 Other acute.	4,246	4,027	4,528	4,503	4,418	4,069	4,008	3,993
412 Chronic	304,962	312,301	321,884	327,722	326,065	313,847	302,362	327,830
413 Angina pectoris	216	200	168	179	175	151	186	206
390-398								
402,404, All diseases of the heart ^b	735,542	743,368	755,864	757,075	738,171	715,318	723,878	718,850
410-429 }								

^aEighth Revision of International Classification of Diseases, adopted 1965.

^bIncludes diseases other than coronary artery disease.

SOURCE: National Center for Health Statistics, Hyattsville, Md., personal communication, 1979.

Table 6.—Death Rates From Coronary Artery Disease, 1970-77 (per 100,000 population)

ICDA code ^a	1970	1971	1972	1973	1974	1975	1976	1977
410-413 Ischemic heart disease.	328.1	327.1	328.8	326.0	314.5	301.7	301.0	295.0
410 Acute MI	175.8	173.5	171.9	167.6	158.1	152.4	148.8	141.6
411 Other acute.	2.1	2.0	2.2	2.1	2.1	1.9	1.9	1.8
412 Chronic	150.1	151.5	154.6	156.2	154.2	147.3	150.2	151.5
413 Angina pectoris	0.1	0.1	0.1	0.1	0.1	0.1	0.1	0.1
390-398								
402,404, All diseases of the heart ^b	362.0	360.5	363.0	360.8	349.2	336.2	337.2	332.3
410-429 }								

^aEighth Revision of International Classification of Diseases, adopted 1965.

^bIncludes diseases other than coronary artery disease.

SOURCE: National Center for Health Statistics, Hyattsville, Md., personal communication, 1979.

disease. As shown in table 7, in 1972, the Health Interview Survey of NCHS found 3,307,000 persons who reported coronary artery disease in its various clinical manifestations. Of these persons, 31.8 percent attributed 1 or more days of bed-disability per year to the condition, and 23 percent attributed more than 1 week. Nearly 58 percent claimed to be bothered somewhat or a great deal by related symptoms. Over 12 million physician visits were attributed to coronary artery disease. In contrast to mortality, data from the Professional Activities Survey, in table 8, show a steady increase in live hospital discharges for coronary artery disease between 1969 and 1977. Inferences from these data must be qualified by the fact that the trends may reflect changes in reporting, increases in the population at risk, or changing patterns of coronary artery disease.

Potential Demand for Cardiac Imaging

Table 9 summarizes the potential future demand for cardiac radionuclide imaging by different target populations. Admittedly, these projections are highly speculative and, in all probability, represent upper bound estimates. Access to imaging facilities and patient or physician attitudes regarding the value of imaging will heavily influence actual utilization.

If all asymptomatic persons 40 years of age and older were studied yearly, the estimated demand from this category alone would be 70.8 million scans per year. Restriction of imaging to persons with suspected or established coronary heart disease leads to estimates of 11.7 million scans per year. These figures do not include scans performed for types of heart disease other than coronary disease (e.g., congenital heart dis-

Table 7.—Prevalence and Morbidity Data for Coronary Artery Disease, 1972

Prevalence		All ages	< 45	45-64	65 plus	
In thousands.....		3,307	167	1,466	1,674	
Per 1,000 persons.....		16.4	1.2	34.7	84.0	
Bed disability days for the condition		Bed-disability days in past year (percent in category)				
Prevalence (000's)	None	1-7	8-14	15-30	31-180	>180
3,307	68.2%	8.8%	5.170	7.2%	7.7%	2.30/o
Discomfort from the condition (percent in category)		Physician visits in past year (percent in category)				
Great deal	Some	Very little	Other		Not bothered	
27.2%	30.7%	15.3%	3.3%		22.8%	
Physician visits		Physician visits in past year (percent in category)				
Prevalence (000's)	None	1	2-4	5 or more	Unknown	
12,271	16.40/.	21.8%	32.7%	26.2%	2.9%	

SOURCES: National Center for Health Statistics, "1976 Summary: National Ambulatory Medical Care Survey: Advance Data," in *Vital and Health Statistics*, series 30 (Hyattsville, Md.: NCHS, 1978); National Center for Health Statistics, "Prevalence of Chronic Circulatory Conditions, United States, 1972," in *Vital and Health Statistics*, series 10, No. 94 (Hyattsville, Md.: NCHS, 1974).

Table 8.—Hospital Discharges for Coronary Artery Disease, 1969-77 (in thousands)

ICDA code ^a	Age group	1969	1970	1971	1972	1973	1974	1975	1976	1977
410.....	40-59	144	137	147	156	154	162	157	163	172
411-413.....	40-59	189	197	230	256	286	298	318	340	348
410.....	60-64	57	50	60	55	55	62	63	70	68
411-413.....	60-64	79	76	88	78	107	106	122	131	125
410.....	All ages	402	390	413	428	423	455	451	481	488
411-413.....	All ages	712	706	792	849	903	903	921	983	977
Total.....	All ages	1,114	1,096	1,205	1,277	1,326	1,358	1,372	1,464	1,465

^aEighth Revision of International Classification of Diseases, adopted 1965. See tables 5 and 6

SOURCE: Professional Activities Survey, Chicago Ill., personal communication, 1979.

Table 9.—Projected “Demand” for Cardiac Imaging

Indication	Number of persons (in millions)	Number of scans/person/year ^a	Number of scans (in millions)
Screen, asymptomatic ^b adults	70.8	1	70.8
Suspected CAD ^c	3.1	1.25	3.9
Definite CAD ^d	3.9	1.5	5.8
Monitor drug therapy in CAD ^e	0.6	2	1.2
Monitor CABS patients ^f	0.4	2	0.8
Total projected scans	—	—	82.5
Excluding routine screening.	—	.	11.7

CAD = coronary artery disease

CABS = coronary artery bypass surgery

Assumptions:

^aThe number of scans per year estimates are entirely arbitrary. In principle they represent yearly screening for all categories of patients with either increased frequency or more than one type of scanning procedure per patient for the more complicated categories.

^bEstimated US population 40 years and older for 1976 minus the estimated number of Patients with suspected or definite CAD

^cRate of suspected CAD in adults (2.2 percent) determined in the 1960-62 National Health Examination Survey applied to the

estimated 1976 adult population.

^dSame as (c) for definite CAD (rate 2.8 percent); includes acute myocardial infarctions.

^eNational Health Interview Survey (52) estimated that 79 percent of patients who acknowledge CAD have a treatment pre-

scribed. It is assumed that 20 percent of these might require periodic monitoring of drug effect ($0.2 \times 0.79 \times 3.9 = 0.6 \times 10^6$).

^fIt is estimated that 100,000 persons receive CABS per year. Assuming an average survival of 4 years, there will be 400,000 prevalent patients with CABS (well may be underestimated).

ease, rheumatic heart disease, myocardio-pathies, and unclassified types of heart disease).

Another method for projecting numbers of cardiac scans involves the use of ambulatory care data (51). These data indicate that in 1976 there were over 54 million office visits for diseases of the circulatory system (ICDA 390-458) and that over 19 million EKGs were performed.

If only one out of four office visits generated a scan, or, alternatively, if one of every two EKGs were replaced by a scan, then 13.5 million scans or 9.5 million scans, respectively, would be generated from the ambulatory care sector alone. No matter what assumptions one makes nor what techniques one employs, the potential demand for cardiac imaging is enormous.

COSTS AND CHARGES

Costs of a Radionuclide Laboratory

To perform a cost analysis of a constantly changing and expanding technological area such as cardiac radionuclide imaging is risky. Today's calculations may be out of date tomorrow. Furthermore, radionuclide imaging laboratories vary widely. A large teaching hospital may have a nuclear medicine department occupying an entire floor or wing, with several technologists, numerous physicians, five scintillation cameras, several computers, and elaborate ancillaries. At the other end of the spectrum, a small rural hospital may provide cardiac imaging services once a month by contracting on a per-scan basis with a mobile imaging service. Most community hos-

pitals fall somewhere between these two extremes, with one or two cameras, a small computer, and a technologist.

Analysis is further complicated by the fact that discounts from list prices of up to 40 percent are available on many items of equipment and on some radionuclides. Producers may even give new equipment to prestigious institutions or investigators at no charge to promote the equipment through subsequent publication of research results. Finally, most radionuclide laboratories are not fully dedicated to cardiac studies. Under these circumstances, the proportion of costs attributable to cardiac scans must be estimated. Given the rapid expansion of cardiac imaging, this proportion is ever changing.

In the following analysis, costs are assessed for a hypothetical laboratory with one scintillation camera and one small computer. It is assumed that the laboratory is fully dedicated to cardiac imaging and that maximum production capacity of the laboratory is realized. To the extent that economies of scale might be realized in larger laboratories through more efficient use of personnel or through purchase of computers capable of handling the inputs from two cameras, our costs estimates will be high. To the extent that larger laboratories will purchase more expensive equipment (e.g., a computer capable of handling dual inputs or more elaborate accessories), however, these economies of scale will be counterbalanced. It should be noted that any unit cost estimates that assume maximal efficiency of production are bound to be optimistic. Equipment downtime, illness of key personnel, uneven demand for services, and scheduling problems all militate against achieving optimal productivity.

Many different schema are available to categorize the costs of production of a service. We use the following nomenclature:

1. *Direct nonlabor costs.* —Fixed, including equipment and service contracts or maintenance; and variable, including radionuclides and other disposable.
2. *Direct labor costs.* —Fixed or variable, depending on whether alternative uses of time and skill exist when personnel are not doing cardiac imaging. Personnel for a radionuclide laboratory typically include a technol-

ogist, a physician, and a secretary/receptionist.

3. *Indirect costs.* —Overhead costs (administration, space, utilities); training costs.

Direct Nonlabor Costs: Fixed

The single most expensive item of equipment is the scintillation camera. The price varies with the characteristics of the camera itself, accessories obtained with it, and size of discount available. Table 10 summarizes 1979 list prices of current models from several producers. The average base price is \$90,000, with a range from \$78,000 to \$110,000. Accessories can increase these prices by 30 to 70 percent.

The second major equipment item is the computer. Although a computer is not essential for qualitative analysis of thallium perfusion studies, it is required for calculation of transit times, for ventricular function studies that include calculation of ejection fractions, and for tomographic studies. List prices of basic units range from \$40,000 to \$54,000 (and up for more sophisticated multipurpose systems), with an average of \$49,000.

Accessories for the camera and computer, including collimators, visual display, and software packages, are estimated for purposes of this analysis to amount to 25 percent of the base price. Their cost can be considerably greater.

Other equipment items required to perform scans include an examination table, bicycle ergometer for exercise studies, radiation counters

Table 10.—List Prices of Selected Equipment Suitable for Cardiac Radionuclide Imaging^a

Equipment item	Producer	Model	List price
Camera.	Picker	DynaCamera 4/15-61	\$110,000+
		DynaCamera 4/15-37	\$96,000 +
	GE	MaxiCamera 11	\$80,000-\$120,000
	Searle	Pho/Gamma V	\$78,000-\$150,000
	Ohio Nuclear	Sigma 410 S	\$85,000-\$100,000
Computer.	ADAC	Clinical Acquisition Module II	\$40,000 +
	MDS	A ²	\$53,000 +
	Searle	Scintiview	\$49,000 +
	Digital	Gamma 11-1134	\$54,000
System.	Baird	System 77	\$99,500-\$170,000

^aOnly the most recent model is listed for each product of a given type of equipment. The range for a given item is accounted for by accessories that can be purchased with the basic equipment.

and badges, Polaroid film, magnetic tapes or disks for data storage, etc. The costs of this "other" category are difficult to estimate. The figure of \$10,000 that we adopt in this analysis was provided by one laboratory director.

The aforementioned capital expenditures (camera, computer, accessories, "other"), which are annualized in this analysis by amortization over a 7-year period at a real interest rate of 5 percent (above inflation), are shown in table 11. The choice of the period of amortization depends on the physical and technological lifetimes of the equipment, as well as on the accounting practices of the institution. Scintillation cameras 10 years old are still in use, and many are capable of being updated as technological developments occur. Computer technology, on the other hand, is evolving more rapidly. Even though the physical life of a computer may well be 7 years, its technological life maybe consider-

ably shorter; 5 years was proposed by some experts. Our choice of 7 years is a compromise that probably errs on the side of underestimating annual costs of a radionuclide laboratory. At the extreme, for example, a laboratory director might propose annual or biannual updating or replacement of equipment to retain state-of-the-art scanning capability. In fact, it is the desire on the part of some institutions to remain current that helps to fuel markets for both new and used equipment. The international market for used equipment allows less wealthy facilities to perform cardiac radionuclide scans at reduced cost.

The costs of maintenance must be added to capital expenditures. Most producers offer service contracts, most commonly at an annual cost of 10 percent of the basic purchase price. As shown in table 11, for purposes of this analysis, the annual cost of a service contract is estimated to be \$14,000.

Table 11.—Estimated Annual Fixed Costs of Operating a Radionuclide Imaging Laboratory^a

Direct nonlabor costs (fixed)	Average purchase price		Annual costs
Equipment			
Camera/computer/accessories ^b	\$174,000		\$30,000
Other ^c	10,000		1,700
Service ^d	14,000		14,000
Subtotal	—		\$45,700
Direct labor costs^e			
	Annual salary (plus 20% fringe)	Full-time equivalent	Annual cost
Technologist	\$24,000	1.0	\$24,000
Physician	84,000	0.2	16,800
Secretary/receptionist.	12,000	0.3	3,600
Subtotal	—	—	\$44,400
Indirect costs			
	Average cost		Annual cost
Overhead ^f			\$22,500
Technologist training ^g	\$5,000		1,200
Subtotal	—		\$23,700
Total annual cost.			\$113,800

calculations assume a single camera/computer system. Some economies of scale might be achieved in laboratories having more than one system.

^bAverage list price of basic equipment plus 25 percent for accessories. Average prices: camera \$90,000; computer \$49,000. Annual costs assume a 7-year amortization period at a 5-percent real interest rate.

^cFor examination tables, exercise equipment, EKG machines, radiation counters, etc. Estimated to total \$10,000. Annual cost again assumes a 7-year period and a 5-percent interest rate.

^dUsual service contract is 10 percent of base price per year ($0.10 \times \$139,000 = \$13,900/\text{year}$).

^eAnnual salaries represent current full-time equivalent estimates based on interviews with the personnel of several laboratories.

^fscaled down to requirements of a laboratory with a single scanning system.

^gEstimated as 25 percent of total direct costs (48).

^hCould range from zero if a fully trained technologist is hired to as high as \$10,000 if an untrained person is trained on the job.

The assumption of \$5,000 is a compromise. Annual cost considers a 5-year duration of employment and a 5-percent real interest on the investment in training.

Direct Nonlabor Costs: Variable

The major variable nonlabor cost is for radio-pharmaceuticals. Table 12 presents list prices for thallium-201 and for the technetium-99m generators and cold product kits provided by New England Nuclear. Several factors must be considered. First, 30- to 50-percent discounts are available for technetium generators and cold product kits; however, the price for thallium is relatively fixed, because New England Nuclear is the sole producer. Second, the radioactive half-life of the isotope is a major consideration in estimating costs. Thallium is supplied by the dose, has a 74-hour half-life, and is generally used within 24 hours of delivery; the necessity for thrice-weekly deliveries, at \$16 per delivery, adds to the already high cost. Technetium, on the other hand, is supplied weekly in the form of generators of variable specific activity. The molybdenum parent has a half-life of 67 hours, while the half-life of technetium-99m is 6 hours. Therefore, greater efficiency is achieved by scheduling patients for examination early in the week after Saturday deliveries. Technetium-99m

must be produced from the generator daily for immediate use. Again, scheduling is critical. Third, unit dose costs for technetium depend on congruence between the size of the generator and the number of patients examined. Any excess capacity of a generator will be wasted.

Direct Labor Costs

Labor costs may be fixed or variable, depending on whether or not the personnel involved have responsibilities other than cardiac imaging. Most laboratories have the following personnel: 1) a technologist, usually fully dedicated to radionuclide imaging, though often performing scans other than cardiac scans; 2) a physician (or nuclear medicine expert plus consulting cardiologists and internist) who supervises operation of the laboratory, evaluates patients, places intracaths when required, monitors exercise, supervises data analysis, and interprets the results of the study; and 3) a secretary/receptionist who schedules appointments, greets patients, and types reports. (Except in large laboratories, the secretary/receptionist has responsibilities other than cardiac imaging.)

Table 12.—List Prices of Radionuclides (Thallium-201, Technetium-99m) and Cold Product Kits^a

Thallium-201 ^b				
Amount shipped		Price/dose	Usual dose	Comment
1.65 mc		\$93.50	1.5-2.0 mCi	Calibrated for day of delivery. Must add \$16 delivery charge per order.
Technetium-99m generators				
Amount		Price	Usual dose	Comment
New scale	Old scale			
225	50 mc	\$169	15-25 mCi	New scale represents radioactivity at time of delivery. Old scale is radioactivity remaining on Friday after a Saturday delivery. Must add a \$22 delivery charge per generator.
450	100	224		
675	150	279		
900	200	334		
1,350	300	445		
1,800	400	555		
2,250	500	666		
2,640	600	776		
Cold product kits ^d				
Amount		Price/kit	Price/vial	Comment
1-4 kits		\$92	\$18.40	Each kit contains 5 vials. Each vial is sufficient for 2 doses.
5-9		86	17.20	
10 or more		69	13.80	

^aList prices are those quoted by New England Nuclear (NEN). NEN is the sole sources for thallium. Small discounts (10 to 15 percent) are given for large orders. List prices of other producers of technetium and cold product kits are competitive; 35-50 percent discounts are available for Tc-99m.

^bT_{1/2} of Tl-201 is 74 hours.

^cT_{1/2} of molybdenum parent is 67 hours; T_{1/2} of Tc-99m is 6 hours.

^dShelf life 1 year; therefore, large purchase feasible even if volume is relatively low.

Full-time equivalent (FTE) salaries of personnel, of course, vary from institution to institution. Estimated average salaries, including 20-percent fringe benefits, are:

Technologist: \$24,000 (base salary \$20,000)
 Physician: \$84,000 (base salary \$70,000)
 Secretary: \$12,000 (base salary \$10,000)

A tradeoff exists between employing a technologist who is less qualified than one represented by a \$20,000 base salary and increased physician time spent in supervising activities of the laboratory. Our assumptions, we believe, are fiscally conservative.

Annual salaries, estimated FTEs for a laboratory of the size being evaluated, and annual direct labor costs are summarized in table 11.

Indirect Costs

Indirect costs fall into two categories: 1) overhead expenses for administration, space, and utilities; and 2) costs of technologist training. Overhead costs are estimated to be 25 percent of total annual direct costs (nonlabor and labor) (48), or \$22,500 (see table 11). Technologist training could range from zero, if a fully trained person were hired, to perhaps \$10,000 if an inexperienced person were trained on the job by the supervising physician. Our chosen figure is \$5,000, which is annualized by amortization over an expected 5-year period of employment at a 5-percent real interest rate.

Total Annual Fixed Costs

As shown in table 11, estimated total annual fixed costs of our model radionuclide laboratory are \$113,800. To this figure must be added the variable costs of radiopharmaceuticals and disposable. Enlargement of this laboratory to accommodate increased demand for scans would, in essence, involve the stepwise addition of similar units at comparable costs, or at somewhat reduced costs if efficiencies of scale were realized.

Unit Costs of Cardiac Imaging Procedures

The unit costs of different types of cardiac imaging procedures are calculated by summing an-

nual nonlabor costs prorated over the number of procedures of a given type that a laboratory could perform in 1 year, estimated labor costs per procedure, and the cost of radionuclides and other disposable.

Prorated annual nonlabor costs are obtained from estimates of the daily production capacity of a laboratory if it were totally dedicated to one type of procedure (see table 13) the number of workdays per year (250 days), and the annual nonlabor costs (direct plus indirect). Nonlabor costs range from \$27.76 to \$92.53 per test.

Labor inputs in time (minutes) and dollar equivalents are summarized in table 14. Estimates for technologist and physician times were obtained from several laboratory directors and checked by a time-motion study in one laboratory; those for secretarial inputs are the authors'. Time estimates varied widely from one laboratory to another, probably because of the differences in the amount of responsibility delegated to the technologist, or the varying sophistication of available computer software and resulting differences in the time required for data analysis. Values chosen represent approximate medians. *

*An alternative method for estimating labor costs per procedure would be simply to divide annual direct labor costs by the number of procedures performed per year by the laboratory. This method assumes that all labor costs should be ascribed to individual procedures. Labor costs estimated by using this method range from \$17.76 for first-pass studies (rest) to \$59.20 for thallium perfusion studies (exercise-redistribution).

Table 13.—Production Capacity for Cardiac Imaging Procedures

Procedure	Number per day
Thallium-201 perfusion studies	
Rest	8
Exercise	5
Exercise-redistribution	3
Technetium-99m studies	
<i>First-pass studies</i>	
Rest	10
Exercise	6
<i>MUGA studies</i>	
Rest	8
Exercise	5
Infarct imaging ("Hot spot")	8

*Assumes that an 8-hour workday is totally devoted to a given type of test
 Estimates were obtained from discussions with laboratory directors

Table 14.—Personnel Time Required for Different Cardiac Imaging Procedures and Estimated Cost Equivalents^{ab}

Procedure	Technologist		Physician		Secretary		Total
	Time	\$	Time	\$	Time	\$	\$
Thallium-201 perfusion studies							
Rest	50	\$11.40	10	\$8.00	10	\$1.15	\$20.55
Exercise	80	18.30	40	32.00	10	1.15	51.45
Exercise-redistribution	120	27.40	50	40.00	20	2.30	69.70
Technetium-99m studies							
<i>First-pass studies</i>							
Rest	40	9.10	30	24.00	15	1.70	34.80
Exercise	70	16.00	60	48.00	15	1.70	65.70
<i>MUGA studies</i>							
Rest	60	13.70	30	24.00	15	1.70	39.40
Exercise	90	20.55	60	48.00	15	1.70	70.25
Infarct imaging ("Hotshot")	60	13.70	10	8.00	10	1.15	22.85

^aTime estimates are the medians of figures quoted by several laboratory directors. Estimates vary widely from one laboratory to another, in part, at least, in relation to the degree of responsibility delegated to the technologist.
^bDollar equivalents are based on annual salary plus fringe estimates (table 11) and an assumed 1,750 work hours per year (250 workdays x 7 hours of work/day, excluding lunch and breaks) Hourly rates: technologist \$13.70; M.D. \$48.00, secretary \$690

Costs of radionuclides plus disposable per test are estimated to be \$95.50 per dose for thallium studies and from \$15.53 to \$18.66 for technetium studies.

Unit costs calculated as the sum of these several components are presented in table 15. Rest studies are less costly than exercise studies,

because rest studies avoid both the extra time required for exercise (20 to 30 minutes) and the need for physician supervision. Thallium studies are more costly than technetium studies because of the greater cost of the isotope. First-pass studies are less expensive than MUGA (multiple-gated acquisition) studies, because first-pass studies require less imaging time.

Table 15.—Unit Costs of Cardiac Imaging Procedures Assuming Maximal Production Efficiency

Procedure	Non labor costs		Labor costs	Total costs
	Fixed ^a	Variable ^b		
Thallium-201^c perfusion studies				
Rest	\$34.70	\$95.50	\$20.55	\$150.75
Exercise	55.42	95.50	51.45	202.37
Exercise-redistribution	92.53	95.50	69.70	257.73
Technetium-99m studies^{d,e}				
<i>First-pass studies</i>				
Rest	27.76	15.53	34.80	78.09
Exercise	46.27	16.73	65.70	128.70
<i>MUGA studies</i>				
Rest	34.70	15.98	39.40	90.08
Exercise	55.52	18.66	70.25	144.43
Infarct imaging ("Hot spot")	34.70	15.98	22.85	73.53

^aAssumes 250 workdays per year and production capacities as estimated in table 13.
^bEstimated costs per dose for radionuclides and cold product kits, if required, plus \$3 for other disposables (syringes, etc.).
^cThe cost for thallium assumes list price plus a delivery charge per dose of \$2.00 (\$93.50 + \$2.00 = \$95.50).
^dThe cost for technetium assumes that the median test in a week is done after one radioactivity half-life, a dose of 20 mc, a 40-percent discount off list price, and a \$22 delivery charge per generator

No tests per week	Required mc	Generator size required	Discounted cost + \$22	Cost/dose
50	1,000	2,250	\$421.60	\$ 8.43
40	800	1,800	355.00	8.88
30	600	1,350	289.00	9.63
25	500	1,350	289.00	11.56

^eThe cost for the stannous pyrophosphate cold product kits used with gated blood pool and "hot spot" scans assumes purchase of a 1 year's supply, 2 doses per vial, and a 40-percent discount (price = \$4.10 per dose).

Our cost estimates must be interpreted with certain caveats. First, it is unlikely that any laboratory would devote itself totally to one type of test. If more than one type of test were performed, the weighted production capacity might increase or decrease, thus affecting costs. For example, more efficient scheduling might be possible with shorter studies interdigitated with longer ones. On the other hand, greater expertise of personnel with a particular type of test would probably enhance efficiency. Numerous tradeoffs can be imagined. Second, it is unlikely that any laboratory would live up to its production capacity day in and day out. To the extent that production capacity is not realized, our results will underestimate true unit costs. On balance, however, we believe that the calculated unit costs are reasonable.

Current Charges for Cardiac Imaging Procedures

There is enormous variation both in the nomenclature on which charges for imaging procedures are based and in the charges themselves. In some regions of the country, a single fee is charged for procedures categorized very much as we have categorized them. In other regions, each view (e. g., left anterior oblique, anterior) is charged for separately, and charges vary depending on the extent of data analysis performed. Fragmentation of charges into those ascribed to the nuclear medicine department, to the exercise laboratory, and to the physician is another common practice that tends to increase total charges.

Anecdotal reports from several physicians active in cardiac imaging suggest that actual charges for a thallium perfusion study at rest and during exercise range from as low as \$300 to as high as \$1,000. Similar ranges apply to technetium (first-pass and MUGA) studies. Clearly, standardization of nomenclature and equitable determination of costs (and hence reimbursements) are issues that are only now beginning to be confronted.

Third-Party Reimbursements

A recent survey performed by the National Blue Cross and Blue Shield Association indi-

cated wide variations in the reimbursement formulas being employed by member plans. Two different approaches to the problem of achieving better standardization of policies are represented by the activities of Blue Cross/Blue Shield of Greater New York and Blue Cross/Blue Shield of Massachusetts. *

In New York, concerns have developed over rapid increases in the volume of scanning by independent as well as hospital laboratories and the ill-defined nomenclature which permits fragmentation of charges. Efforts are being directed to consolidate the number of codes for which reimbursements will be provided and to define an equitable global fee schedule. Reimbursement is (and apparently will continue to be) provided whether the procedure is performed in a hospital laboratory or an independent laboratory.

In Massachusetts, a different approach has been taken. Here, Blue Shield has defined codes (very similar to our own classification) and, with the help of an advisory committee, has established basic benefits and interim customary scales that are limited to the professional component. Since Blue Cross covers the basic service component only for scans performed in hospital laboratories, this decision by Blue Shield has, in effect, limited the ability of independent laboratories to perform scans.

Suggested Fee Schedules

Global fee schedules suggested by three laboratory directors are presented in table 16. As can be seen, fees for rest studies of all types are about \$250, whereas those for studies that involve exercise or exercise combined with rest range from \$350 to \$405. The range of proposed fees is considerable, especially for exercise studies. These suggested fees are not necessarily representative of the United States at large. It is probable that the true range of charges is in fact much greater.

Comparison of the information in tables 15 and 16 indicates that unit costs for thallium stud-

* Massachusetts: Dr. James Young, Medical Director, Massachusetts Blue Shield, Boston, Mass., personal communication, 1979.

Table 16.—Suggested Fee Schedules for Cardiac Imaging Procedures^a

Procedure	Charge (range)	Midpoint of range
Thallium-201 perfusion studies		
Rest	\$245-\$250	\$248
Exercise	315-420	368
Exercise-redistribution	315-495	405
Technetium-99m studies		
<i>First-pass studies</i>		
Rest	260-275	268
Rest and exercise	315-475	395
<i>MUGA studies</i>		
Rest	225-260	243
Rest and exercise	315-385	350
Infarct imaging ("Hot spot")	150-160	155

^aProvided by three laboratory directors. Physician proportions estimated to be between 30 and 40 percent of total charge.

ies average about 60 percent of proposed fees (range 56 to 65 percent); and unit costs for resting first-pass studies, resting MUGA studies, and infarct imaging are 29, 37, and 47 percent of proposed fees, respectively. Comparisons could not be drawn for exercise studies done alone, since fee schedules address exercise studies only when they are performed in conjunction with their resting counterparts.

Another way to examine suggested fee schedules is to calculate the volume of testing required to defray the costs of laboratory operations. Table 17 presents these results under the assumption that the laboratory is totally devoted to the

production of one type of test only. Breakeven volumes represent between 18 percent (resting first-pass studies) and 49 percent (exercise-redistribution thallium studies) of projected full production capacities. Volumes above these levels would represent profit to the institution.

Differences found between resource costs and charges may be due to underestimation of unit costs or to the fact that substantial profit margins are built into proposed fee schedules. Arguments can be made on both sides of this issue. Quite clearly, this problem warrants further exploration.

Table 17.—Breakeven Points for Laboratory Operation^a

Procedure	Production capacity (per year)	Breakeven volume (per year)	Percent of capacity
Thallium-201 perfusion studies			
Rest	2,000	746	370/0
Exercise	1,250	418	33
Exercise-redistribution	750	368	49
Technetium-99m studies			
<i>First-pass studies</i>			
Rest	2,500	451	18
Rest and exercise	— ^b	—	—
<i>MUGA studies</i>			
Rest	2,000	501	25
Rest and exercise	— ^b	—	—
Infarct imaging ("Hot spot")	2,000	819	41

calculations use estimated annual fixed costs of laboratory operations (table 11), variable costs (radiopharmaceuticals (table 15), and midpoints of suggested fees for different cardiac imaging procedures (table 16).

^bNot estimable because production capacities were estimated on the basis of exercise tests done alone, while suggested fee schedules were for exercise studies only when done in conjunction with rest studies.

CLINICAL EFFICACY

In the broadest sense, a diagnostic test should be evaluated in terms of its ability to improve the medical outcomes of patients to whom it is applied; earlier and more effective treatment regimens should result. However, most diagnostic tests serve only as elements in the physician's decisionmaking process, which also involves inputs from multiple sources, including the patient's history of symptoms, the presence of risk factors, and findings on the physical examination. Furthermore, the relation between management decisions and patient outcome is not always clear. For these reasons, the evaluation of a diagnostic test is usually limited to its information content, while resultant patient benefits are implied. Each of these limitations applies to the evaluation of the efficacy of cardiac radionuclide imaging.

Medical Literature: Overview

Early papers describing the development of the current generation of cardiac imaging procedures appeared in the 1960's and early 1970's, and an explosion of clinical investigations began in 1977.

Several generalizations will facilitate interpretation of the medical literature. First, most studies have been conducted in a small number of medical centers in the United States. Second, almost all studies have been performed in highly selected populations. Subjects have been patients with chest pain who have been referred to the hospital for evaluation and cardiac catheterization or patients admitted with suspected or proven myocardial infarction. "Normal" patients have been those found to have either minimal or no coronary artery disease on coronary angiography or, in a few instances, have been hospital controls or normal volunteers. No information is currently available from an unselected population.

Third, the "gold standards" against which radionuclide procedures have been judged are: 1) the coronary angiogram for the diagnosis of coronary artery disease; 2) the left ventricular angiogram for the assessment of left ventricular

function; and 3) a combination of clinical, enzymatic, and electrocardiographic findings for the diagnosis of acute myocardial infarction. Each of these "gold standards" has very definite limitations. The coronary angiogram provides an anatomic demonstration of coronary disease, but the correlation between anatomic disease and impaired blood supply to the myocardium (the root cause of angina pectoris and myocardial infarction) is only approximate. Two problems exist. On the one hand, interpretation of the degree of vessel narrowing from a coronary angiogram is highly subjective; interobserver variability of between 15 and 35 percent for different coronary arteries was noted in one carefully performed study (88). On the other hand, even accurate determination of the degree of coronary artery narrowing will not necessarily correlate with degree of reduced blood flow or the risk of an untoward myocardial event; the length, nature, and location of the obstruction and the existence of collateral blood supply are also important. Coronary arteriography is an imperfect indicator of physiologically significant disease, but it is indispensable to the selection of patients for coronary artery bypass surgery. The left ventricular angiogram is also an imperfect standard. Interobserver variability in the interpretation of wall motion abnormalities has been reported to be as high as 42 percent. The diagnosis of acute myocardial infarction is, at present, made on the basis of composite information from the clinical history, changes in the EKG, and increased levels of certain cardiac enzymes (SGOT, CPK, MB-CPK). False-negative results are indicated by the identification of the pathological changes of myocardial necrosis on post-mortem examination in patients with ischemic disease who do not evidence infarction by the above criteria during life (58). False-positive results are probably rare if stringent criteria are employed.

Finally, it is important to note that all of the information in the medical literature on cardiac radionuclide imaging has been generated by experts in nuclear radiology and cardiology. Since performance of imaging procedures is technical-

ly exacting, data analysis difficult, and interpretation to a large extent subjective, results presented below are likely to represent the best achievable with the technology existing at the time the studies were conducted. As diffusion occurs, the technical quality of scans that are performed may decline. At the same time, the procedures may be applied to populations very different from those in which currently available information was obtained. These factors, coupled with the rapid changes that are occurring in the state of the technology, make it very difficult to predict the true clinical effectiveness of cardiac scans in widespread applications.

Diagnostic Information

The value of diagnostic information lies in the contribution that it makes to diagnosing a disease or to documenting the extent of disease or its response to treatment. Underlying this criterion is the assumption that increased knowledge somehow confers benefits to the patient.

Diagnosis of a Disease

Diagnosis implies that one has a clear definition of what constitutes a disease. This is not always simple. Many diseases represent a point on a continuum of a physiologic or pathologic phenomenon, rather than a discrete entity. Coronary artery disease is an example. Furthermore, most diagnostic tests are less than perfect indicators of a disease, no matter how it is defined. The likelihood that a disease exists is increased by a "positive" result and decreased by a "negative" result, but in neither case is the diagnosis "certain." Under these circumstances, the usefulness of a test to the clinician will depend on several factors:

- the probability that disease exists given the characteristics of the patient tested;
- the change in disease probability that can be attributed to the test result; and
- the threshold probability level that must be reached for the physician to make the next diagnostic or therapeutic decision, i.e., to proceed with further tests or with treatments if the likelihood of the disease is sufficiently high or to stop testing if it is sufficiently low. This threshold, in turn, should

depend on the clinical implications of falsely diagnosing a disease that is not present (false positive) or missing the diagnosis of a disease that is present (false negative).

The principles involved in this decision process are summarized by Bayes' theorem, which relates the probability of the disease if a test is positive to the probability of disease prior to the test and to test sensitivity and specificity, such that:

$$P(D+ | T+) = \frac{P(T+ | D+) \times P(D+)}{P(T+ | D+) \times P(D+) + P(T+ | D-) \times P(D-)}$$

where: $P(D+ | T+)$ is the posterior probability of the disease
 $P(T+ | D+)$ is the sensitivity of the test
 $P(D+)$ is the prior probability or prevalence of the disease
 $P(T+ | D-)$ is the false-positive rate, which in turn is 1 minus the specificity of the test or $[1 - (T- | D-)]$
 $P(D-)$ is the prior probability that the disease is absent or $[1 - P(D+)]$

Vecchio (77) and McNeil, et al. (46) discuss the assessment of diagnostic information in general, and Diamond and Forrester (20) relate these concepts to the diagnosis of coronary artery disease in particular.

As discussed below, the application of Bayes' theorem to clinical decisionmaking requires careful definition of several parameters: 1) what is meant by disease presence or absence; 2) the criterion for test positivity, and how this relates to sensitivity and specificity; and 3) the characteristics of the population being tested as they relate to the prevalence of disease (prior probability) and to test sensitivity and specificity.

Disease Presence or Absence. —Disease can be defined by pathologic, anatomic, or physiologic criteria. The criterion chosen will have important implications for the sensitivity and specificity of a diagnostic test and for disease prevalence in the population. The point on the continuum of pathophysiologic abnormalities one uses to define the presence of disease also will have important implications. Development of the pathologic lesions of coronary artery disease begins early and progresses throughout life. Clinical consequences may include sudden death, myocardial infarction, angina pectoris, and congestive heart failure.

Pathologically, coronary artery disease is defined by the presence of arterial lesions or by changes in the myocardium consistent with ischemic damage. The continuum is from minimal to extensive changes. Assessment of cardiac imaging techniques according to pathologic findings has relied on post mortem examinations, biopsies done at the time of coronary artery bypass surgery, and, in one study, transvenous myocardial biopsies (36). In general, practical difficulties in obtaining pathologic material have limited applications of this criterion.

Anatomic manifestations of coronary artery disease are usually assessed by coronary arteriography. The risks and costs of this procedure limit its application to patients in whom coronary artery disease is strongly suspected. Hence, it will be difficult or impossible to use coronary arteriography in a general population to evaluate cardiac imaging techniques. The presence of disease by coronary arteriography is defined by the percentage reduction in luminal diameter of a vessel. Criteria vary, but narrowing of greater than 70 percent is the most common definition of "significant" disease. Additional criteria relate to the number of vessels involved, the location of lesions, and the extent of involvement (local or diffuse). That obstruction of less than 70 percent may be designated "nondisease" is an obvious dilemma.

Physiologic expressions of coronary artery disease include typical symptoms of angina pectoris, abnormal electrocardiographic changes during exercise, and measurement of enzymes released from damaged tissue (CPK) or metabolites released from an ischemic myocardium (lactate). From many points of view, physiologic criteria should be the most useful of all clinically. For myocardial infarction, a combination of physiologic changes is, in fact, the "gold standard."

Criterion for Test Positivity.—Test sensitivity, test specificity, and false-positive and false-negative rates all depend on the criterion selected to identify a positive test. For thallium perfusion scans, for example, detection of a defect depends on the extent of count rate deviation from normal patterns. The effects of the

choice of cutoff criterion on sensitivity and the false-positive rate can be depicted in a receiver operating curve as shown in the following figure.

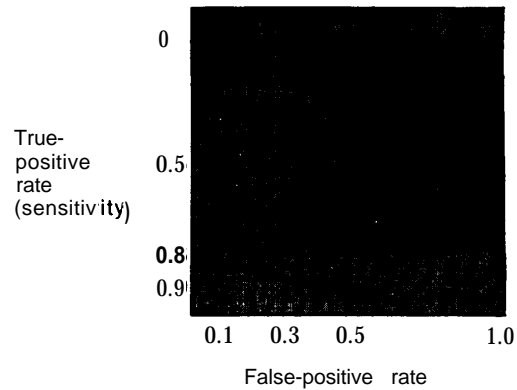

If a 25-percent reduction in count rate were specified (point A), the sensitivity might be 0.85 and the false-positive rate 0.20. If a lesser reduction were chosen, a larger proportion of true positives would be identified, at the cost of a higher false-positive rate (point B). The converse would occur if a more stringent criterion were chosen (point C).

When quantitative analysis of data is performed, a 20- to 25-percent reduction in count rates is usually selected. When subjective interpretations are made, the criterion is a qualitative one based on the identification of a definite or probable defect. Even with standardization in the technical performance of a procedure, variations in interpretation between observers and between laboratories will have important effects on the comparability of results.

Disease Prevalence.—Finally, the value of a test can be assessed only if the prior probability of the disease in the patient is known. Considerable data are available that relate the independent contributions of sex, age, and the characteristics of chest pain to the likelihood of coronary artery disease (20,85). For example, the likelihood of disease in asymptomatic persons ranges from 0.3 percent in women 30 to 39 years of age to 12.3 percent in men 60 to 69 years of age. If typical angina is present, comparable figures are 25.8 percent and 94.3 percent, respectively. In-

formation from prior diagnostic tests, such as a resting EKG or exercise tolerance test, would modify probabilities based on age, sex, and chest pain.

Not only will the prior probability of disease in a population have an important effect on the posterior probability, but it also may have an effect on the sensitivity and specificity of a particular diagnostic test. This phenomenon has been demonstrated clearly in the case of exercise tolerance testing. Chaitman, et al. (19), for example, studied 200 patients with suspected coronary disease prior to cardiac catheterization. All had normal resting EKGs. Eighty-six percent of 87 men with typical angina, 65 percent of 64 men with atypical angina, and 28 percent of 49 men with nonspecific chest pain were found to have coronary artery stenoses (of at least 70 percent). In patients with typical angina, the sensitivity of exercise tolerance testing was 87 percent and the specificity was 100 percent; in patients with atypical angina, corresponding figures were 64 and 83 percent. Weiner, et al. (85) verified these findings in a large prospective study of coronary artery disease. The sensitivity of the exercise tolerance test in that study ranged from 85 percent in patients with definite angina to 53 percent in patients with nonischemic pain; corresponding values for specificity were 67 and 77 percent. In women with definite angina, sensitivity was 85 percent and specificity only 49 percent; however, the number of women with nonischemic pain was too small to permit meaningful estimates. Clearly, the sensitivity and specificity of cardiac imaging procedures must be examined in various population subgroups before one can extrapolate with confidence from studies currently available.

The relevant parameters having been defined, Bayes' theorem can be applied to assess the relation between prior and posterior probabilities of disease and hence the value of diagnostic information. This relation can be displayed as shown in the figure that follows.

The shapes of the curves for abnormal and normal results are determined by the specificity and sensitivity of the test in question. The hypothetical example shown portrays a test with a

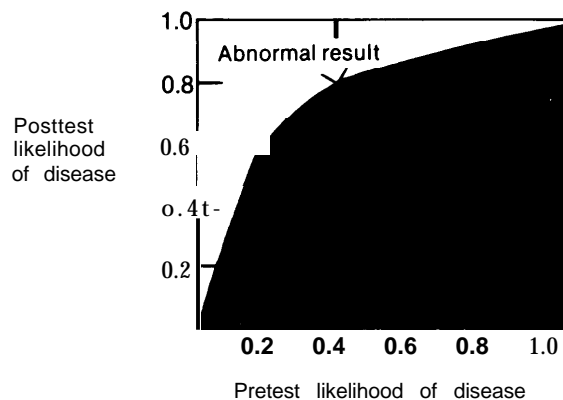

specificity of about 85 percent and a sensitivity of about 70 percent. If the pretest probability were 0.4, then the posttest probability would be about 0.8 if the test were abnormal and 0.2 if the test were normal, probability differences of 0.4 and 0.2, respectively. If the physician's threshold for proceeding to the next diagnostic step (e.g., cardiac catheterization) were 0.8, the test results would allow that decision. If the posterior probability in the face of a positive test were lower than the threshold for decisionmaking, however, the value of the test would be dubious. Other decisions or other physicians might have different thresholds. The effectiveness of a test, therefore, depends both on the posterior probability of disease achieved and on the influence that the probability would have on a physician's choice of further diagnostic or therapeutic actions.

Physician thresholds for action in the face of the need to make decisions with less than perfect data have not been evaluated systematically. Information from such studies could make important contributions to physician education as well as to the evaluation of physician performance and the utilization of medical technology.

Cardiac Imaging Procedures: Review of the Medical Literature

Our review of the literature addresses each of the major clinical uses of cardiac imaging procedures: 1) diagnosis of coronary artery disease; 2) diagnosis of acute myocardial infarction; 3) assessment of ventricular function; and 4) follow-

up of patients undergoing coronary artery bypass operations. Also discussed are problems of interobserver variability in the interpretation of scans and questions of safety.

Diagnosis of Coronary Artery Disease

Medical Decisions Affected.—Determination of the cause of chest pain has important implications for prognosis and for the choice of treatment. In patients in whom the diagnosis of coronary artery disease is strongly suspected, the major alternatives are to offer a trial of medical treatment or to proceed to coronary angiography with the view that coronary artery bypass surgery would be recommended if the results of this study revealed “operable” disease. Some experts argue that high-risk, though asymptomatic, patients should also be evaluated because of the increased risk of “sudden death” in these individuals. To date, however, the value of medical or surgical treatments in this group has not been demonstrated convincingly.

Techniques.—Thallium-201 perfusion studies and technetium-99m ventriculographic techniques have both been used to diagnose coronary artery disease. As discussed earlier, coronary artery disease appears as perfusion defects in the former technique and as wall motion abnormalities or abnormalities in regional or global ejection fractions in the latter. Results are summarized for thallium-201 studies in table 18 and for technetium-99m studies in table 19.

Definition of Disease.—The “gold standard” for defining the presence of coronary artery disease is the coronary arteriogram. Limitations of this procedure were discussed previously. As indicated in tables 18 and 19, the criterion for diagnosis may range from roughly 50-percent to at least 75-percent obstruction of one or more coronary arteries. This range may in part represent the use of different nomenclatures, 50-percent diameter narrowing being equivalent to about 75-percent reduction in luminal area. To the extent that real differences in criteria exist, test results will be difficult to compare among studies.

Populations Studied.—Essentially all studies have been performed in patients with suspected

coronary artery disease who have undergone coronary arteriography. Most have chest pain of some type; many have had prior myocardial infarctions. Specification of the proportion of patients with typical or atypical angina pectoris is presented in a minority of studies (1, 4, 18, 45, 47, 54, 71, 78). Disease prevalence ranges from 50 to 82 percent.

Results.—The overall sensitivity of thallium-201 studies for the detection of coronary artery disease ranges from 75 percent (81) to 100 percent (73), with an average of 86 percent, while specificity ranges from 56 percent (73) to 100 percent (1,81), with an average of 89 percent. In general, sensitivity seems to be greater in studies having a larger proportion of subjects with prior myocardial infarctions. No relation of sensitivity to the criterion chosen for definition of the disease was apparent in the one study that examined this directly (54). The single study that used seven-pin-hole tomography (81) reported by far the highest sensitivity (97 percent), with a specificity of 100 percent. Direct comparison of tomography to the standard perfusion scan in this study suggested the greater sensitivity of the tomographic methods. Further validation of the superiority of this technique is needed, however.

Comparison of thallium scan results to exercise tolerance tests poses a special problem, because, while the latter detect only myocardial ischemia sufficient to depress the ST segment a prescribed amount, exercise or exercise-redistribution scans detect both fixed perfusion defects (usually reflecting areas of myocardial scar) and transient defects occurring during exercise. The proper comparison, therefore, depends on whether the desired endpoint is the detection of any coronary artery disease (CAD) or the detection of transient ischemia only.

Average unweighed results from studies that compare the thallium scan and exercise tolerance test (ETT) in the same population show:

	<u>Thallium</u>		<u>ETT</u>	
	<i>Sens.</i>	<i>Spec.</i>	<i>Sens.</i>	<i>Spec.</i>
Any CAD (N=14), ..	8370	86%	6370	80%
Ischemia (N=4)	7070	8570	60%	8570

Table 18.—Thallium-201 Perfusion Scans in the Diagnosis of Coronary Artery Disease

Author	Year	Selection criterion	Subjects					Disease definition ^a	Disease prevalence	Test results				Comments		
			Total	AP	Atyp	Other	Prior MI ^b			TI-201			ETT			
									R/RD	Ex	Overall					
Lenears, et al. (34)	1977	Admitted for CA	70	—	—	—	27	≥ 50%	79%	—	S = 95%	—	—	Segmental analysis performed.		
Ritchie, et al. (64)	1977	Suspected CAD Admitted for CA	101	—	—	—	21	≥ 50%	75%	S = 29%	S = 66%	S = 76%	S = 45%			
Bailey, et al. (1)	1977	CA proven CAD (63 pts); normal (17)	83	40	3	—	48	≥ 70%	76%	Sp = 96%	Sp = 96%	Sp = 92%	Sp = 84%			
Turner, et al. (76)	1978	Chest pain but no prior MI	66	—	—	—	0	≥ 75%	53/70	S = 49%	S = 56%	S = 75%	S = 38%	S of ETT = 54% if endpoints of ST depression and chest pain are combined.		
										Sp = 100%	Sp = 100%	Sp = 100%	Sp = 100%	Excluded from study were patients with prior MI, patients unsuitable for ETT or if predicted submaximal heart rates not achieved. Also excluded were patients with coronary artery obstruction > 50%, but < 75%.		
Veroni, et al. (78)	1978	Suspected CAD with CA	82	53	26	2	4	≥ 50%	59%	—	S = 79%	—	S = 88%	ETT results exclude 26 patients with nondiagnostic results (on medications or 85% predicted rate not achieved).		
										SP = 97%	—	—	Sp = 62%			
Carrillo, et al. (18)	1978	Suspected CAD with CA	55	32	17	6	22	≥ 75%	71%	—	S = 87%	—	S = 54%	ETT results include 27 patients in whom results were equivocal.		
Okada, et al. (54)	1978	Suspected CAD with CA	49	36	9	4	10	≥ 70%	67%	S = 39%	S = 69%	S = 84%	S = 92%	Calculations exclude 3 rest and 2 exercise scans that were technically unsatisfactory.		
										Sp = 80%	Sp = 60%	Sp = 60/0	Sp = 71%	18 of 49 ETTs were nondiagnostic and are excluded.		
Blood, et al. (4)	1978	Suspected CAD with CA	87	68	—	0	32	≥ 70%	71%	Rest	S = 32%	S = 90%	S = 93%	S = 66/0	Redistribution scans were more sensitive than rest scans.	
										RD	S = 92%	Sp = 84%	Sp = 76%	Sp = 86%		
Botvinick, et al. (13)	1978	Chest pain with CA	65	—	—	—	19	≥ 75%	63%	S = 56%	S = 89%	S = 93%	Sp = 88/0	Sp = 80%	Sp = 76%	
Vogel, et al. (81)	1979	CAD with CA	65	—	—	—	—	≥ 70%	65%	—	S = 85%	S = 67%	—	—	ETT calculations exclude patients with equivocal results.	
										—	Sp = 92%	Sp = 63%	—	—	7-pinhole tomography compared with standard scintigraphy.	
										—	S = 74%	Standard	—	—		
										—	Sp = 96%	—	—	—		
										—	S = 95%	7-pinhole	—	—		
										—	Sp = 96%	—	—	—		
										—	S = 69%	S = 94%	S = 97%	S = 60%	Redistribution of > 20%	
Meller, et al. (47)	1979	Chest pain with normal CA	27	15	12	0	—	≥ 50%	82%	Sp = 100%	Sp = 100%	Sp = 100%	—	—	ETT uninterpretable in 3 patients.	
Massie, et al. (43)	1979	Chest pain with CA	78	—	—	—	33	≥ 70%	82%	O Sp = 93%	Sp = 85/0	Sp = 85/0	Sp = 60%	—		
Sonnemaker, et al. (73)	1979	Referred for CA	36	—	—	—	—	≥ 70%	75%	—	—	S = 100%	S = 44%	S = 89%	Uses processed-lesion enhancement. Without processing S = 85%, Sp = 56%. ETT calculations count 11 indeterminate results as not abnormal	
Bodenheimer, et al. (8)	1979	Chest discomfort with CA	95	—	—	—	—	≥ 75%	77%	—	—	S = 75%	S = 56%	Sp = 86/0	With asynergy on LV angiogram as the endpoint TI-201 sensitivity = 93%.	
McCarthy, et al. (45)	1979	Known or suspected CAD with CA	128	—	—	—	43	≥ 70%	74%	—	S = 87%	—	S = 88%	60 patients on propranolol. ETT calculations are for diagnostically adequate tests.		
										—	Sp = 85%	—	Sp = 85%	—		
										—	S = 81%	—	—	—	Nondiagnostic ETTs occurred in 39 patients. TI-201 stress abnormal if a new or enlarged defect was noted compared to the redistribution scan.	
										—	Sp = 69%	—	—	—	New or enlarged defect on stress TI-201 scan	
Stolzenberg, et al. (74)	1979	CA	52	—	—	—	—	≥ 70%	67%	—	S = 83%	—	S = 55%	Calculations excluded 6 patients with equivocal scans or ETT results.		
										—	Sp = 94%	—	Sp = 82%	—	Propranolol therapy associated with a decrease of sensitivity of TI-201 scans from 90% to 76% and specificity from 82% to 53%.	
Pohost, et al. (57)	1979	CA	227	—	—	—	—	≥ 50%	71%	—	—	S = 87%	S = 63%	Sp = 75%	Sp = 77%	

CA = coronary arteriogram s = sensitivity R/RD = rest or redistribution
 CAD = coronary artery disease Sp = specificity EF = cardiac ejection fraction
 MI = myocardial infarction ETT = exercise tolerance test HR = heart rate
 AP = angina pectoris Ex = exercise LV = left ventricular
 Atyp = atypical angina pectoris

^aHistory and/or Q waves.

^bPercent obstruction of at least one coronary artery.

Table 19.—Technetium-99m Radionuclide Angiography in the Diagnosis of Coronary Artery Disease

Author	Year	Selection criterion	Subjects					Disease definition ^a	Disease prevalence	Test results				Comments
			Total	AP	Atyp	Other	Prior MI ^b			Technetium-99m		TI.201	ETT	
										R	Overall			
Rerych, et al (63)	1977	30 normals 30 with CAD	60	-	-	-	-	≥ 75%	50%	First-pass studies S = 27% S = 83%* S = 97%... Sp = 100%				● Criterion for abnormality: abnormal wall motion; ● rise in ejection fraction with exercise of ≥ 0.05% Isometric handgrip exercise
Bodenheimer et al (7)	1978	Chest pain with CA	129	-	-	-	-	≥ 75%	76%	S = 67% S = 91% Sp = 84% Sp = 84%	-	-	-	● Criterion for abnormality is decreased relative regional EF
Bodenheimer et al (9)	1978	Suspected CAD with CA	44	-	-	-	-	≥ 75% (and LV asynergy)	82%	S = 82% Sp = 100 %/0	-	-	-	Rest only. Criterion for abnormality is abnormal segmental wall motion
Slutsky, et al (71)	1979	32 normal volunteers, 48 with chest pain and CA	80	48	-	-	-	≥ 70%	60%	S = 96% Sp = 100 %/0	-	-	-	Rest only. Single crystal camera First-third EF (NL = 0.29 ± 0.04) is criterion for abnormality, Sensitivity of global EF at rest = 35%.
Bodenheimer et al (6)	1979	Chest pain with CA	75	-	-	-	-	≥ 75%	75%	-	S = 82% S = 82% S = 58% Sp = 79% Sp = 890%. Sp = 840/.	-	-	Q waves in 15 patients Combined sensitivity of all tests = 960/.
Borer, et al (12)	1979	Suspected CAD with CA	84	-	-	-	-	≥ 50%	75 %/0	MUGA studies s = 54% s = 94% ● Sp = 100% S = 89%/0* Sp = 100%				● Regional dysfunction with exercise. ● Global EF c normal
Caldwell, et al (15)	1979	CA	52	-	-	-	-	≥ 50%	82%	S = 93% S = 85% Sp = 54 %/0 Sp = 100%	-	-	-	

CA = coronary arteriogram
 CAD = coronary artery disease
 MI = myocardial infarction
 AP = angina pectoris
 Atyp = atypical angina pectoris
 s = sensitivity
 Sp = specificity

ETT = exercise tolerance test
 Ex = exercise
 R/RD = rest or redistribution
 EF = cardiac ejection fraction
 HR = heart rate
 LV = left ventricular

^aHistory and/or Q waves
^bPercent obstruction of at least one coronary artery

NL = normal level

The results for exercise tolerance tests must be interpreted with caution because of varying practices in counting equivocal results and the inability of some patients to attain adequate exercise levels. The highest sensitivities were obtained in studies that excluded indeterminate results (45, 54, 76, 78). Nonetheless, thallium perfusion studies appear to be at least as sensitive and specific as the exercise tolerance test in detecting myocardial ischemia. Treatment with propranolol for angina pectoris or for hypertension at the time of testing appears to decrease the sensitivity and specificity of thallium studies (57) and to decrease the number of patients able to attain 85 percent of the predicted maximal heart rate on exercise tolerance tests.

Fewer studies have evaluated the effectiveness of radionuclide ventriculography in diagnosing coronary artery disease (6, 7, 9, 12, 15, 63, 71). Studies employing regional wall motion abnormalities as the criterion for a positive test indicate an average sensitivity of 89 percent and an

average specificity of 88 percent (table 19). Two studies comparing radionuclide ventriculography to the thallium-201 perfusion in the same patient population demonstrate similar sensitivity estimates but lower specificity for ventriculography (6, 15). Abnormalities in the response of ejection fractions to exercise and measurement of the first one-third of ejection fraction at rest also appear to be promising criteria for the diagnosis of coronary artery disease (7, 71).

Diagnosis of Acute Myocardial Infarction

Medical Decisions Affected.—Between 20 and 50 percent of patients admitted to coronary care units with chest pain syndromes ultimately prove not to have had an acute myocardial infarction. Care at home or less intensive care in the hospital may suffice for patients with chest pain but no infarction. Hence, early and accurate exclusion of myocardial infarction may obviate unnecessary admissions, with consequent savings in patient inconvenience and cost.

Current indices of infarction—clinical history, EKG, or enzyme elevations—are either insufficiently sensitive or specific or may not confirm the diagnosis for several days. Better tests are needed.

Techniques.—Two radionuclide techniques have been applied to the diagnosis of acute myocardial infarction: thallium-201 and technetium-99m pyrophosphate infarct imaging. The former identifies an infarcted area as a perfusion defect (“cold spot”); the latter isotope concentrates in the infarcted area and creates a “hot spot.” The technetium pyrophosphate technique has several drawbacks. First, a study may be falsely negative if circulation to an infarcted area is completely obstructed. At least limited perfusion is required to allow the radionuclide to reach the infarcted area. Second, the test does not become maximally sensitive until 24 hours after the onset of symptoms. Hence, it is of limited value in helping to decide whether to admit a patient to the hospital. Finally, a small but significant number of patients remain positive for several months after an infarction, thus creating the potential for false-positive results. Thallium studies, on the other hand, are most sensitive during the first 24 hours, but cannot distinguish new from old infarctions.

Definition of Disease.—Invariably, acute myocardial infarction is defined in terms of the clinical history and the electrocardiographic and enzymatic changes that are observed over a number of days of hospitalization.

Populations Studied.—Most studies have been performed on patients admitted to coronary care units or on patients with documented myocardial infarctions.

Results.—Results for technetium-99m and thallium-201 studies are summarized in table 20. Sensitivity for technetium-99m studies ranged from 74 to 100 percent and averaged 93 percent for studies done 24 or more hours after admission. False-negative results related primarily to small or nontransmural myocardial infarctions. Specificity, where measurable, averaged 78 percent. False-positive results occurred especially when diffuse uptake and minimal focal uptake were included in the criterion for an abnormal

test. In three studies that directly compared thallium-201 and technetium-99m techniques, sensitivities were approximately equal (3,69,83).

Assessment of Ventricular Function

Medical Decisions Affected.—Objective evaluation of left ventricular function is needed in at least four clinical circumstances. First, in patients with heart failure of uncertain cause, it is needed to identify surgically treatable disease (e.g., left ventricular aneurysm). Second, it may serve to exclude from cardiac catheterization and surgery patients who would be untreatable surgically or who would have an unacceptably high risk associated with surgery (e.g., patients with cardiomyopathy). Third, objective evaluation of ventricular function may help guide medical treatment aimed to improve symptomatic heart disease or to monitor unwanted side effects of certain drugs on the heart (e.g., those of the anticancer agent, adriamycin). Finally, ventricular function studies in patients with lung disease may help to establish whether shortness of breath is pulmonary or cardiac in origin; treatment will vary accordingly.

Techniques.—The technetium-99m radionuclide ventriculographic techniques described earlier can be used to determine the several parameters of right and left ventricular function.

Definition of Disease.—The medical history, physical examination, and routine laboratory studies may be insufficient to determine the cause of ventricular failure. Cardiac catheterization and the contrast ventricular angiogram typically are used in situations where ambiguity exists. Disease is defined in terms of abnormalities in pressures, blood flows, and myocardial contractility observed at rest and during exercise.

Populations Studied.—Patients with various types of heart disease who have been studied by cardiac catheterization.

Results.—Agreement between radionuclide and contrast ventriculograms in the evaluation of ventricular function has been excellent. Correlation coefficients for left ventricular ejection fraction comparing first-pass studies to contrast studies average 0.90 (range 0.80 to 0.95) (9,23,42,61). Comparisons of MUGA studies to con-

Table 20.—Technetium.99m Stannous Pyrophosphate (“Hot spot”) and Thallium.201 Perfusion Scans in the Diagnosis of Acute Myocardial Infarction^a

Author	Year	Select Ion criterion	No of subjects	Prevalence of disease	Time from MI to test	Test results		Comments
						Tc-99m	Tl-201	
Parkey, et al (56)	1974	Admission to CCU	23	65%	1-5 days in 19 7-10 days in 4	S = 1000/0 ;Sp = 1000/0 s = 500/0	—	Good correlation with EKG localization of MI in all patients with positive scans
Wackers, et al (84)	1976	Documented MI	200	100%	c 6 hr in 44 <24 hr in 96 24-48 hr in 36 3-10 days in 68	— — —	S = 100 % S = 94% S = 58% S = 79%	Defect size decreased in first 24 hr in patients with repeat scans
Mann, et al (41)	1978	Documented MI	20	100%	< 1 wk in 18 at 1 mo in 18 at 9 mo in 18	S = 830/0 S = 61% s = 17%	—	Persistently positive scans detract from value of Tc-99m to diagnose acute MI.
Holman, et al (31)	1978	Admissions to CCU	100	590/0	1-6 days	s = 100 % Sp = 520/.	—	False positives occurred with diffuse or slight focal uptake especially in patients with unstable AP. S = 1000/.
Holman, et al (30)	1978	Admissions to CCU	31	48%	4-8 hr 24 hr	s = 73 % s = 100% Sp= 88%	—	Focal uptake the criterion for abnormality 2/16 patients with unstable AP had focal uptake.
Wackers, et al (83)	1978	Patients with Inferior MI	78	1000/0	≥ 24 hr	S = 82%	S = 100 %	Of patients with I MI 38% showed RV involvement
Hoilund-Carlisen, et al (28)	1978	20 patients with MI 18 without MI	38	53% ⁴	?	s = 100% Sp = 83%	—	Criterion for positivity was “definite uptake “
Sharpe, et al (69)	1978	Acute TM MI	26	100%	< 72 hr	s = 100%	s = 100%	
Berger, et al (3)	1978	55 patients with TM MI and 25 with NTM MI	80	100%	2-12 days	s = 950/0	s = 91%	Excellent correlation with EKG localization of MI.
Massie et al (44)	1979	31 with NTM MI, 43 with TM MI, 40 with stable AP	114	65%	1-5 days	Overall. S = 74 % TM: S = 91% NTM: S = 52% Overall. Sp = 90%	— —	4 false positives in patients with AP had diffuse uptake Diffuse uptake non-specific, discrete uptake highly specific but insensitive in NTM MI
Poliner, et al (58)	1979	59 studies in 52 patients who later had post mortem examinations or surgical myocardial biopsies	52	600/0	?	s = 94% Sp = 57%	—	All 12 false positives in patients with unstable or stable AP had pathological evidence of multifocal necrosis or fibrosis

CCU = coronary care unit AP = angina pectoris
MI = myocardial infarction S = sensitivity
TM MI = transmural MI Sp = specificity
NTM MI = nontransmural MI RV = right ventricular
IMI = inferior MI

^aIn all cases, the diagnosis of acute MI was established by history, EKG changes, and enzyme elevations.

trast studies average 0.88 (range 0.84 to 0.93) (22,23,61,79,82), and those comparing first-pass to MUGA studies average 0.93 (range 0.87 to 0.94) (23,61,82).

Evaluations of regional ejection fraction abnormalities by radionuclide techniques have been fewer, in part because of the need for sophisticated computer programs. Available results show excellent agreement with contrast ventriculography, both for the localization of dysynergic (poorly contracting) areas and for quantification of the degree of impaired contractility (9, 22, 79). In a study of patients with con-

gestive heart failure, similar patterns of left ventricular dysfunction by contrast and radionuclide techniques were demonstrated in 34 of 36 patients (53). This paper also reported that of 82 patients studied, 4 patients were scheduled for cardiac catheterization because scans disclosed potentially operable left ventricular aneurysms, and 20 patients were excluded from catheterization because of extensive ventricular dysfunction that would effectively preclude surgery. This is the only study reviewed that directly addressed the question of the potential of radionuclide studies to substitute for cardiac catheterization.

Evaluation of the Results of Coronary Artery Bypass Surgery

Medical Decisions Affected.—Evaluations of patients who undergo coronary artery bypass operations aim to determine the etiology of residual chest pain and to permit more judicious prescriptions for physical activity and medical treatments.

Techniques.—Thallium-201 studies have been used to evaluate improvements in pre-existing perfusion defects following surgery, while technetium-99m pyrophosphate studies help to determine the incidence of postsurgical myocardial infarctions.

Populations Studied.—Patients who have undergone coronary artery bypass operations, most of whom were studied by radionuclide

techniques, as well as by coronary arteriography and contrast ventriculography, preoperatively.

Results.—Tables 21 and 22 summarize selected studies using thallium-201 and technetium-99m infarct imaging scans, respectively. Postoperative exercise thallium scans show improved perfusion in 70 to 80 percent of patients. Excellent correlation with graft patency was shown in the two studies in which postoperative scans and coronary arteriograms were systematically compared (26, 65). The resolution of persistent as well as transient (exercise) defects has raised questions about the interpretation that resting thallium defects represent old myocardial infarctions (2). The limited number of technetium-99m studies reviewed suggest that this technique is more specific than either enzymes or the EKG in identifying postoperative myocardial infarctions.

Table 21.—Thallium-201 Perfusion Scans in the Evaluation of Coronary Artery Bypass Surgery Results

Author	Year	Select ion criterion	Number of subjects	Results
Ritchie, et al. (65)	1977	Imaging before and after CABS	20	Exercise perfusion improved in 7 of 11 patients. In 13 of 20, there were no new or enlarged defects postop; graft patency in these was 87%. In 7 of 20 with new defects, graft patency was 54%.
Veroni, et al. (79)	1978	Imaging before and after CABS	23	Exercise scans improved in 19 patients but become normal only in 9.
Greenberg, et al. (26)	1978	Imaging after CABS	27	Postop catheterization in all patients: 17 with recurrent chest pain; 10 because MD wanted information on graft patency. Cath criterion \geq 75% obstruction. Exercise tolerance test: sensitivity 60%, specificity 86%; equivocal results in 6 patients. Scintigram: sensitivity 67%, specificity 100%. In 7 patients with preop and postop scintigrams who had postop cath, correlation with successful revascularization was excellent.
Robinson, et al. (67)	1978	Imaging before and after CABS	36	21 patients had no evidence of ischemia on TI-201 scan postop; all symptom free. 15 patients had unchanged or decreased ischemia; 8 had angina. Perioperative myocardial damage noted in 8 patients.
Leppo, et al. (35)	1979	Triple vessel CAD: 20 with CABS	30	One-half of abnormal preop scintigrams resolved. TI-201 stress/reperfusion imaging correlated "well" with complete revascularization.
Berger, et al. (2)	1979	Imaging before and after CABS	22	37 of 48 transient defects (77%) resolved postop; as did 13 of 18 "persistent" defects.

CABS = coronary artery bypass surgery
CAD = coronary artery disease

Table 22.—Technetium-99m Pyrophosphate Scans in Patients Who Have Had Coronary Artery Bypass Surgery

Author	Year	Number of subjects	Results
Klausner, et al. (33)	1977	51	10 of 51 patients had positive scintigrams postoperatively; in 8, EKG and enzymes were also positive; in 2, enzymes were positive.
Lowenthal, et al. (38)	1977	44	29 patients developed abnormal enzymes or EKG postoperatively. 2 had positive scans. Scintigrams the most specific criterion.
Roberts, et al. (66)	1979	27	Tc-99m glucoheptonate. Of 7 patients with positive postop scintigrams, 4 had abnormal EKGs and enzymes and 3 had abnormal enzymes only.

Technical Challenges and Interobserver Variability

The technical aspects of radionuclide studies—patient evaluation, proper injection of the required quantity of radionuclide, adequate exercise during exercise studies, proper positioning of the scintillation camera, choice of count times, and important analytic factors such as background subtraction and edge detection—all are vital to achieving optimal results. That problems arise is exemplified by Okada, et al. (55), who reported that 5 of 98 studies were technically unsatisfactory. Additional references to scans that were uninterpretable or of marginal quality were frequent. Furthermore, the laboratory directors who were interviewed indicated that as many as 5 percent of studies had to be repeated because of technical inadequacies.

The interpretation of radionuclide studies involves considerable subjectivity and, even in the hands of experts, may result in important interobserver and intraobserver variations. Blood (4) indicated interobserver disagreements in 8 percent of studies, and Massie (43) found interobserver disagreement for 13 percent of myocardial regions and intraobserver differences in 10 percent of images.

Careful evaluation of MUGA imaging in one institution (55) revealed interobserver variances for the estimation of ejection fraction of 6.0 to 8.8 percent in resting studies and 9.6 to 14.0 percent in exercise studies. These variances were comparable to those for left ventricular angio-

grams (11.6 percent). Intraobserver variances were of the same order of magnitude. To increase confidence in results, the authors advocated an average of at least two determinations for calculations of exercise-induced changes in ejection fractions.

It is important to re-emphasize that results reported in the medical literature represent the best that can be obtained by current technology. Authors of these papers are experts, and often the innovators, in nuclear medicine. They have, by and large, the best equipment that is available, perform studies meticulously, and take great care in data analysis and interpretation. As diffusion occurs, technical problems and interobserver variations are almost certainly going to increase.

Potential Risks From Cardiac Imaging

Potential risks from cardiac imaging fall into two categories: risks due to exposure to radiation and nonradiation risks.

Nonradiation risks relate to emotional or physical trauma to the patient as a result of the cardiac imaging procedure. Anxiety precipitated by the procedure's results—needless anxiety if the results are falsely positive or inadequately explained—may be significant. Pain, development of a hematoma or infection at the site of injection, and the small but definite risk of a cardiac arrest or myocardial infarction during an exercise test are the physical effects to be considered. These potential adverse effects must all

be weighed against the benefits of the information to be derived from the procedure. Information with which to quantify these nonradiation risks does not appear in the literature.

The risks of exposure to radiation may be of greater concern. Populations that are exposed include not only the patients, but also producers of radionuclides, transport workers, users, and persons involved in the disposal of radioactive wastes. Despite the importance of broader environmental and economic issues related to the use of radionuclides, attention in this case study is limited to the risks incurred by the users and patients.

Actual radiation exposures experienced by technologists, physicians, and other hospital employees working in or around radionuclide laboratories *were* not determined. Radiation safety regulations require staff members to wear film badges that monitor radiation exposure. We assume (perhaps optimistically) that these regulations are observed and that any unusual exposures would be detected before significant risk was incurred. Radionuclide exposure to these personnel, other than spillage onto skin or clothing, would be through the walls of the container. Because electron energies of less than 150 keV,

the levels of technetium and thallium, barely penetrate glass or plastic, the risk is probably minimal.

At greater risk is the patient, and especially the patient who undergoes repetitive scans over a period of years for purposes of screening or for monitoring treatment of an established disease. Typical whole-body and selected organ radiation doses for cardiac radionuclide procedures and for chest X-ray and mammography are shown in table 23. Factors that determine organ exposure include radionuclide dose per test; radiation half-life (6 hours for technetium-99m and 74 hours for thallium-201); the affinity of the organ for the particular chemical form of radionuclide employed; excretory route; and the number of tests performed. The total body exposure from radionuclide scans is similar to that for mammography and is well within radiation exposure guidelines. Judging from the recent controversy over the potential risk from yearly breast cancer screening with mammography, however, care needs to be taken in evaluating the potential long-term effects of repeated low-dose radiation exposure. Too little is known at the present time.

Table 23.—Radiation Exposure From Cardiac Radionuclide Imaging and Selected Radiodiagnostic Procedures

Irradiation site	Procedure and radiation exposure (millirads)				
	Tl-201 ^a	Tc-99m pyrophosphate ^b	Tc-99m pertechnetate ^c	Chest X-ray ^{d*}	Mammography
Total body	360	130	320	3.3	100
Skeleton	—	590	—	—	—
Bone marrow	510	420	—	—	—
Kidneys	2,200	2,100	—	—	—
Bladder: 2 hour void	—	1,460	2,400	—	—
4.8 hour void	—	3,450	—	—	—
Skin	—	—	—	59	2,000
Testes: 2 hour void	—	150	—	—	—
4.8 hour void	810	230	270	—	—
Ovaries: 3 hour void	—	140	—	—	—
4.8 hour void)	850	230	370	—	—
Heart: normal	—	110	—	—	—
impaired)	510	220	790	—	—

^aEstimated absorbed radiation dose to a 70-kg patient following injection of 1.5 mCi of Tl-201.

^bEstimated absorbed radiation from an intravenous injection of 15 mCi of Tc-99m-labeled stannous pyrophosphate into a 70-kg patient undergoing bone Or cardiac ("hot spot") imaging. About half the dose is retained in the skeleton, and half is excreted into the bladder. The skeletal area of highest intake may receive up to 5,900 millirads

^cEstimated absorbed radiation one-half hour after an intravenous injection of 20 mCi of Tc-99m-labeled sodium pertechnetate into 70-kg patient undergoing MUGA Imaging.

^dPersonal communication from Dr. Jacob Shapiro, Cambridge, Mass. e posterior, anterior and lateral.

COST= EFFECTIVENESS ANALYSIS

How can available information be used to evaluate the cost effectiveness of cardiac radionuclide imaging procedures? What are the alternative diagnostic strategies to which radionuclide imaging should be compared? For what specified populations? What are the limitations of cost-effectiveness analysis (CEA) for diagnostic procedures in general and for cardiac radionuclide imaging procedures in particular? What additional information is needed to evaluate the potential benefits and costs of radionuclide imaging? These are the questions to be addressed in the discussion below.

Framework for Analysis

Who Is the Decisionmaker?

To be most useful, CEA must be tailored to the perspective of the particular decisionmaker. One decisionmaker's cost and benefit priorities may differ from those of another decisionmaker. Our own analysis takes the perspective of a Congress interested in allocating limited public dollars to medical care in such a way as to achieve maximal medical benefits. Nonmedical costs and benefits are ignored. This perspective differs, of course, from that of the patient who is interested primarily in out-of-pocket costs compared to medical benefits, or the physician interested in his or her own net income and professional satisfaction, as well as in the patient. Health maintenance organizations and third-party reimbursers will have still other sets of priorities.

Measures of Cost

Costs to be considered are the total of incremental or marginal costs that can be attributed directly to the performance of the test. These include the following:

- Direct cost of the tests. For our decisionmaker, these costs would be the reimbursements to be provided out of tax dollars for tests done on Medicare and Medicaid patients.
- Cost of any tests that need to be repeated because of technically inadequate results.

- Cost of induced tests (tests that would not have been performed had the test in question not been used). Tests may be induced either by abnormal test results or by normal results if the latter are unexpected.
- Cost of tests saved when one test is substituted for another. For example, cardiac radionuclide scanning may substitute in some cases for the exercise tolerance test and/or the coronary arteriogram.
- Cost of treating any adverse effects attributable to the diagnostic test or induced tests.
- Cost of subsequent treatment that can be attributed directly to the availability of the diagnostic test. An example would be the cost of coronary artery bypass surgery in asymptomatic patients with coronary artery disease who would not have been identified had cardiac imaging not been performed. The cost of treatment includes not only its direct cost, but also costs of the treatment of any complications and any savings from the prevention of future morbid events.

Calculation of the net marginal costs of a new diagnostic technology, therefore, requires information on:

1. the direct cost of the new diagnostic test;
2. the direct cost of each diagnostic test that might be substituted for or induced;
3. the direct cost of treatments that might be induced;
4. the indirect cost of each of the above;
5. the likelihood, in each population to which the test would be applied, that additional diagnostic tests or treatments would be induced.

The direct costs of tests are usually readily available or calculable. Indirect costs usually have to be estimated, often from inadequate information. Probabilities of induction or substitution are the most difficult data to obtain and usually become available relatively late during the diffusion of a new technology.

Measures of Effectiveness

Conceptually, the effectiveness of a diagnostic test lies in its information content and in the ability of that information to affect subsequent medical decisions in ways that benefit the patient. As with its costs, a new test's effectiveness must be determined in marginal terms, either in direct comparison with an existing technology that it may replace or as an add-on to existing diagnostic strategies. For technologies with multiple uses and multiple potential target populations, marginal effectiveness should be aggregated over all uses and all populations. Analyses that focus on only a single use or population will not fully describe the technology.

Effectiveness can be assessed at several levels, depending on the availability of data:

- actual health benefit in terms of life-years or quality-adjusted life-years gained;
- treatments affected—with projections of expected health benefits from these; and
- diagnostic information gained—with projections of expected treatment changes and resultant health benefits.

The closer the analysis can come to direct estimates of health benefits, the more conclusive it will be. This is especially true in view of the tenuous relationship that frequently exists between diagnostic information and medical care decisions, and between treatments and subsequent health benefits.

However, very useful C2EAS of diagnostic technologies can rest solely on careful assessment of diagnostic information alone, provided: 1) there is reasonable evidence linking the availability of this diagnostic information to treatment decisions and resultant health benefits; 2) decisions that might be affected are made explicit; and 3) physician thresholds for diagnostic or therapeutic decisions are established. When these conditions are met, the value of diagnostic information will depend on the prior probability of the disease given the patient's characteristics and the results of any prior diagnostic tests; the sensitivity and specificity of the diagnostic test; and the relationship of the resultant posterior probability of disease, given positive or negative

results on the test, to a threshold for a specific decision. The measure of effectiveness, then, becomes the ability of the test to effect an action—the choice of a more definitive diagnostic test or a better treatment.

Example.—A hypothetical example will serve to demonstrate the aforementioned approach. Assume a patient (or homogeneous group of patients) with specified characteristics and a certain prior probability (P_o) of a disease and a disease defined in terms of a generally accepted criterion for offering a specified beneficial treatment (e.g., surgery). The relation between the prior probability (P_o) of the disease and the posterior probability (PP), given the results of a test with known sensitivity and specificity, is provided by Bayes' theorem and is shown graphically for an abnormal test result in the figure below.*

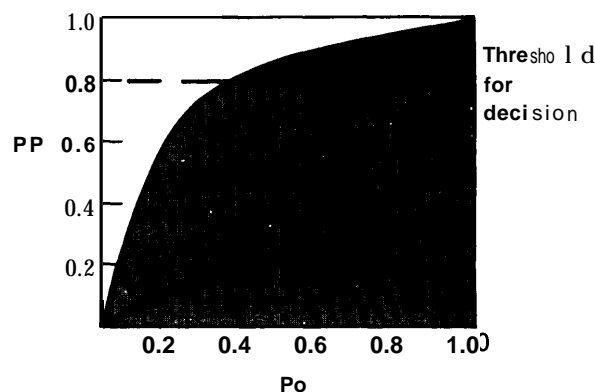

Assume that the threshold for proceeding to a definitive, though more risky, diagnostic procedure that must precede the beneficial treatment is 0.8. If the P_o were 0.1 and an abnormal result were obtained, the PP would be 0.4, a value not sufficiently high to effect an action. If the P_o , on the other hand, were 0.85, a normal result would lower the PP only to about 0.7. It is dubious whether such a finding would dissuade the physician from doing the more definitive study. In this case, the test would be superfluous. Final-

*See previous discussion of Bayes' theorem in the section of this case study on diagnostic information.

ly, a P_o between 0.4 and 0.6, if the test result were abnormal, would lead to a PP in excess of the threshold for action, unequivocally valuable information. Patients with P_{os} in this range would benefit most from the test.

Cost Effectiveness of Cardiac Radionuclide Imaging

costs

Information is available on the direct costs of radionuclide imaging procedures (see unit costs in table 15 and suggested fee schedules in table 16) and the direct costs of the coronary arteriogram and exercise tolerance test. In Boston, the usual charge for a coronary arteriogram (including 2 days of hospitalization) is about \$1,500, and the charge for an exercise tolerance test is \$110.

The costs of treating occasional cardiac arrests and myocardial infarctions precipitated by exercise tolerance tests and a variety of complications from coronary arteriograms can only be speculated upon, and we made no attempt to quantify them for our analysis. Furthermore, no information exists on the extent to which cardiac radionuclide scans substitute for or induce other tests. The most likely substitutions would be for exercise tolerance testing in the diagnosis of chest pain syndromes and for coronary arteriography in the selection of patients who might be candidates for cardiac surgery.

The potential to induce additional testing and treatments would relate primarily to the widespread use of imaging to screen asymptomatic populations for coronary disease. Abnormal screening results would undoubtedly lead to coronary arteriograms in some patients who otherwise would not receive them and to surgery in some patients with "significant" and "surgically correctable" lesions. No evidence exists at present to document the effectiveness of coronary artery bypass surgery in asymptomatic populations; nonetheless, there might be a tendency to extrapolate results from symptomatic groups, in which enhanced survival has been demonstrated, and to offer surgery to such patients.

Effectiveness

On the effectiveness side of the equation, cardiac radionuclide imaging can be judged at present only in terms of the diagnostic information it provides. Effects on treatment decisions and on ultimate health benefits have yet to be evaluated. Even estimates of information content must be considered to be tentative because of the highly selected natures of the populations in which test sensitivity and specificity have been evaluated. Whether comparable results will be obtained in more heterogeneous populations and by average users of the technology remains to be seen.

For purposes of our analysis, we do not distinguish among the various radionuclide procedures. On the average, thallium perfusion, MUGA, and first-pass studies appear to have comparable sensitivities and specificities for the presence of coronary artery disease, though the radionuclide ventriculogram techniques have the advantage of providing additional information on ventricular function not provided by thallium-201 perfusion studies. We also assume that the sensitivity and specificity of scans are not dependent on the prevalence of coronary disease in the population being tested nor on other patient characteristics (an assumption that may well overestimate the value of imaging).

Conditions of the Effectiveness Analysis. —

1. *Definition of coronary artery disease (CAD):* anatomic evidence of at least 70-percent obstruction of one or more coronary arteries.
2. *Decision affected:* to perform coronary arteriography as a precondition to selecting patients for coronary artery bypass surgery. Patients with "definite angina" are considered to meet the criterion for surgery if one or more coronary arteries are diseased. Patients with "probable angina" or "nonischemic pain" are candidates only if they have multivessel disease (MVD). The rationale for these assumptions is based on evidence suggesting that coronary surgery is clearly superior to medical treatment in

relieving angina, regardless of the number of vessels involved, and prolongs life if two or more vessels are diseased.

3. *Threshold probability for the decision to perform coronary arteriography: posterior probability of disease 0.80 or greater.*
4. *Type of chest pain and the prior probabilities of coronary artery disease (20,85):*

Type of chest pain		prevalence of CAD	
		CAD +	MVD +
Definite angina	men	89%	68%
	women	62	39
Probable angina	men	70	40
	women	40	22
Nonischemic pain	men	22	6
	women	5	1
No pain	both	4	(1)*

CAD = any coronary artery obstruction of 70 percent or more.

MVD = obstruction of two or more coronary arteries.

*Assumed value.

5. *Population tested: 200 patients (100 men and 100 women) in each of the four chest pain groups. Total number of patients is 800.*
6. *Sensitivity and specificity of tests for the presence of coronary artery disease: unweighed average figures from the efficacy studies reviewed earlier:*

	Sensitivity	Specificity
Cardiac scans (thallium and technetium).	87%	89%
Exercise tolerance test.	63%	80%

Neither type of test has been shown to differentiate reliably between single-vessel and multivessel disease.

7. *Diagnostic strategies: A variety of diagnostic strategies could be conceived that would involve the simultaneous or sequential application of the various tests used to diagnose coronary artery disease (EKG, exercise tolerance test, radionuclide scans, echocardiography, coronary angiography).*

Strategies would vary, no doubt, with the entry characteristics of the patient. The logical comparison would be between the optimal (or usual) strategy without the new technology and the optimal (or usual) strategy employing the new technology. The difference in effectiveness between these two strategies would be in the

number of surgical candidates correctly identified (true positives), the number of surgical candidates missed (false negatives), and the number of patients needlessly subjected to the risks of coronary arteriography (false positives).

Alternative diagnostic strategies to be considered in our analysis are:

Strategy A: Cardiac radionuclide imaging in all patients; coronary arteriograms in positives; no further tests in negatives.

Strategy B: Cardiac radionuclide imaging in subgroups of patients whose posterior probabilities (PPs) of disease in the face of an abnormal response would be at least 0.80; coronary arteriograms in positives; no further tests in negatives. Coronary arteriography without prior radionuclide imaging in subgroups of patients whose prior probabilities (Pos) of disease are at least 0.80.

Strategy C: Same as A but with exercise tolerance testing.

Strategy D: Same as B but with exercise tolerance testing.

Results of Effectiveness Analysis.—The results of calculations performed under the assumptions specified above serve to emphasize several points (see table 24). First, diagnostic strategies B and D lead to fewer coronary arteriograms, fewer false-positive examinations, and fewer false-negative results than their counterparts, strategies A and C, with no loss in true-positive examinations. Hence, a decision rule based on a threshold cutoff probability to guide the use of diagnostic tests appears to be more effective than a blanket-testing decision rule,

Second, the strategies employing cardiac radionuclide imaging (A and B) result in the identification of more patients requiring surgery and fewer missed surgical candidates than the strategies using exercise tolerance testing (C and D). These advantages are partially offset for strategy B, however, by the fact that a greater number of patients are needlessly subjected to the risks of coronary arteriography.

Finally, several clinical subgroups have calculated posterior probabilities of disease close to, but not reaching, the threshold of 0.8. Probabilities

Table 24.—Effectiveness of Alternative Strategies Employing Cardiac Imaging and Exercise Tolerance Testing To Diagnose Surgically Treatable Coronary Artery Disease

		Patient characteristics				Results for alternative strategies														
Strategy	Symptom category	Sex	No.	Po CAD	No. with CAD	PP/Abnl	No. CA		No. TP		No. FP		No. FN							
							A	B	A	B	A	B	A	B	A	B	A	B		
							S	CAD	S	CAD	S	CAD	S	CAD	S	CAD	S	CAD	S	CAD
Cardiac imaging (strategies A&B)	Definite angina	M	100	0.89	89	0.98	78	100	77	77	89	89	1	1	11	11	12	12	0	0
		F	100	0.62	62	0.93	58	58	54	54	54	54	4	4	4	4	8	8	8	8
	Probable angina	M	100	0.70	70	0.95	64	64	35	61	35	61	29	3	29	3	5	9	5	9
		F	100	0.40	40	0.84	42	42	19	35	19	35	23	7	23	7	3	5	3	5
	Nonischemic pain	M	100	0.22	22	0.69	28	0	5	19	0	0	23	9	0	0	1	3	6	22
		F	100	0.05	5	0.29	14	0	1	4	0	0	13	10	0	0	0	1	1	5
No pain	Both	200	0.04	8	0.25	28	0	2	7	0	0	26	21	0	0	0	1	2	8	
Totals			800		296		312	264	193	257	197	239	119	55	67	25	29	39	25	57
							C	D	C	D	c	D	c	D						
							S	CAD	S	CAD	S	CAD	S	CAD	S	CAD	S	CAD	S	CAD
Exercise test (strategies C&D)	Definite angina	M	100	0.89	89	0.96	58	100	56	56	89	89	2	2	11	11	33	33	0	0
		F	100	0.62	62	0.84	47	47	39	39	39	39	8	8	8	8	23	23	23	23
	Probable angina	M	100	0.70	70	0.88	50	50	25	44	25	44	25	6	25	6	15	26	15	26
		F	100	0.40	40	0.68	37	0	14	25	0	0	23	12	0	0	8	15	22	40
	Nonischemic pain	M	100	0.22	22	0.47	30	0	4	14	0	0	26	16	0	0	2	8	6	22
		F	100	0.05	5	0.14	22	0	1	3	0	0	21	19	0	0	0	2	1	5
No pain	Both	200	0.04	8	0.12	43	0	1	5	0	0	42	38	0	0	1	3	1	8	
Totals			800		296		287	197	140	186	153	172	147	101	44	25	82	110	68	124

Assumptions

- The clinical population studied is composed of 100 men and 100 women with each of the four types of chest pain for a total population of 800 patients
- Health benefits accrue only to patients who subsequently receive coronary artery bypass surgery, while all patients are subjected to the risks of the diagnostic tests employed. Potential health benefits other than those from surgery (e.g., better medical treatment) are ignored
- patient S with definite angina receive surgery if any coronary artery is $\geq 70\%$ obstructed, while patients with other types of chest pain or not chest pain receive surgery only if multivessel disease is present (2 or more coronary arteries obstructed $> 70\%$)
- Prior probabilities of CAD, the sensitivity and specificity of cardiac imaging and exercise tolerance test, and the diagnostic strategies (A,B,C,D) are as stated in the text

Abbreviations:

- s = surgery
- CAD = coronary artery disease
- Po = prior probability
- PP/Abnl = posterior probability if the test is abnormal
- No. CA = number of coronary arteriograms done
- No. TP = number true positives cathed and found to meet criterion for surgery
- No. FP = number of false positives: cathed and found not to meet criterion for surgery
- No. FN = number of false negatives. not cathed and would have met criterion for surgery

bilities at these levels, though not sufficient to sway the decision to do coronary arteriography, might well be sufficient to cause the physician to perform some other noninvasive test. In this case, serial likelihood estimation, in which the previous posterior probability becomes the subsequent prior probability, might be employed in order to reach the threshold for coronary arteriography. This technique, however, requires that the results of different diagnostic tests be independent, a requirement that to date has not been demonstrated convincingly.

Cost-Effectiveness Analysis

The limited CEA of cardiac imaging that is possible provides some useful insights. Our analysis uses charges for laboratory examinations on

the cost side and effectiveness estimates presented in table 24. Costs and effectiveness for each of the alternative diagnostic strategies A, B, C, and D are calculated, and the marginal costs and marginal yields of nondominated strategies are derived.

Discounting is not used since all costs, risks, and benefits (availability of diagnostic information) are immediate. If future benefits from surgery (improved survival, reduced angina) were considered, discounting would be required.

Total costs of alternative diagnostic strategies A, B, C, and D are shown in table 25, and costs are presented with effectiveness estimates in table 26. To rank all strategies by a single cost-effectiveness criterion would require weighting the

Table 25.—Costs of Alternative Strategies To Diagnose Surgically Treatable Coronary Disease^a

Strategy	Coronary arteriograms		Non invasive diagnostic tests		Total cost (\$000's)
	Number	(\$000's)	Number	(\$000's)	
Cardiac imaging					
A (test all).	312	\$468	800	\$280	\$748
B (test threshold).	264	396	300	105	501
Exercise test					
C (test all).	287	431	800	88	519
D (test threshold).	197	296	200	22	318

^aUnit charges: Radionuclide scan—\$350 (average recommended fee for rest and exercise study)
 Exercise test—\$1 10 (local Blue Cross/Blue Shield rate).
 Coronary arteriogram—\$1,500 (local hospital rate in 1978).

Table 26.—Costs and Effectiveness of Alternative Strategies To Diagnose Surgically Treatable Coronary Disease

Strategy	Cost (\$000's)	Effectiveness ^a		
		TP	FP	FN
Cardiac imaging				
A (test all).	\$748	193	119	29
B (test threshold).	501	197	67	25
Exercise test				
C (test all).	519	140	147	82
D (test threshold).	318	153	44	68

TP = true positive, FP = false positive, FN = false negative

^aWith respect to diagnosing surgically treatable coronary artery disease.

different measures of effectiveness so that they could be combined. The weights, in turn, would depend on the relation between the risk to a patient with surgically treatable coronary artery disease who is not identified (false negative), the risk of coronary arteriography in a patient who does not have surgically treatable disease (false positive), and the net benefits from coronary arteriography and surgery (benefits minus risks) in true positives. Such a weighting scheme would be tenuous and is not attempted.

Instead, two other approaches are taken. In one, the assumption is made that a correct diagnosis (true positive) has sufficient value that the negative effects of false positives and false negatives can be ignored. In the second, no such assumption is made, and the strategies are compared qualitatively. Cost-effectiveness comparisons are presented in tables 27 and 28.

In table 27, strategies are ranked from least to most costly, and the incremental costs and benefits are calculated relative to the next less costly strategy. Comparison of strategy B to strategy D reveals that 44 additional true positives cost \$183,000, or \$4,200 per true positive. Strategy C is dominated by B, in that C is both more expensive and less effective. Strategy A is also dominated by B. The average cost per true positive is lowest for D. Whether a decisionmaker would choose strategy D or B would depend on his or her willingness to spend an additional \$4,200 per additional surgical candidate identified.

Qualitative comparisons between strategies are presented in table 28, and these are also interesting. First, strategy A is effectively dominated by B, since A is both more costly and less effective by all three measures of effectiveness. Strategy C is similarly dominated by B. Comparison of B and D (threshold strategies for radionuclide imaging and exercise tolerance testing, respectively) indicates that B buys additional true positives, at a cost, but also results in fewer false negatives and more false positives. If false negatives were in some sense considered to be worse than false positives, the net benefits from B relative to D would be increased further, and the cost-effectiveness ratio for B would become more favorable.

In conclusion, decision strategies based on threshold cutoff probabilities of disease (B and D) are more cost effective than blanket-testing

Table 27.—Cost Effectiveness of Alternative Diagnostic Strategies^a

Strategy	ΔC (\$000's)	ΔE (TP)	Marginal cost/TP — (\$000's)	Average cost/TP - (\$000's)
D		—		\$2.1
B	\$183	44	\$4-2	2.5
C	18	-57		3.7
A	229	53	4.3	3.9
A1	247	-4	∞	

^aAssumes that the values of false-positive and false-negative results are inconsequential compared to true positives. Marginal costs and benefits are calculated relative to the next less costly strategy. Because C is more costly and less effective than B, it is dominated. Similarly, A is dominated relative to B (labeled A1).

Table 28.—Cost-Effectiveness Comparisons Between Alternative Diagnostic Strategies^a

Comparison	ΔC (\$000's)	ΔE		
		TP	FP	FN
A-B	\$247	-4	52	4
C-D	201	-13	103	15
A-C	229	53	-28	-5.5
B-D	183	44	23	-44
A-D	430	40	75	-40
C - B	18	-57	80	59

^aNo assumption is made about the relative values of different outcomes.

strategies. Furthermore, use of cardiac imaging appears to identify additional surgical candidates at reasonable cost when compared to exercise tolerance testing. How reasonable these additional costs are will ultimately depend on the incremental health benefits achieved by coronary artery bypass surgery.

Sensitivity Analysis

Variables upon which our CEA depend include:

- the characteristics of the patient population tested;
- the costs of tests employed;
- the threshold probability for decisionmaking;
- the sensitivity and specificity of scanning in different population subgroups; and
- the diagnostic strategies compared.

Sensitivity analysis can be used to determine the effects on the analysis of changes in assumed values for each of these variables. Here we examine only the importance of the characteristics

of the population tested. Evaluation of the other variables will be the subject of future research.

In our analysis in the previous section, the four diagnostic strategies A, B, C, and D were applied to a mixed population consisting of equal numbers of males and females and equal numbers of patients of each sex with definite angina, probable angina, nonischemic pain, and no pain. A very important policy question, however, relates to the need to define the optimal approach to diagnosis in different target populations. To address that need, strategies A and B (respectively, the test all and threshold strategies for cardiac radionuclide imaging) are evaluated in population subgroups defined by sex and by symptom category. Table 29 summarizes the cost and effectiveness estimates, and table 30 presents cost-effectiveness comparisons.

Strategy A leads to testing in all subpopulations, while by strategy B, testing is performed only in patients with probable or definite angina because of the 0.8 probability threshold required

Table 29.—Costs and Effectiveness of Alternative Strategies Employing Cardiac Imaging To Diagnose Surgically Treatable Coronary Artery Disease in Population Subgroups

Population tested (by symptom)	Sex	Strategy							
		costs (\$000's)	A (test all)			costs (\$000's)	B (test threshold)		
			Effectiveness				Effectiveness		
			TP	FP	FN		TP	FP	FN
Definite angina	M	\$152	77	1	12	\$150	89	11	0
	F	122	54	4	8	122	54	4	8
Probable angina	M	131	35	29	5	131	35	29	5
	F	98	19	23	3	98	19	23	3
Nonischemic pain	M	77	5	23	1	0	0	0	6
	F	56	1	13	0	0	0	0	1
No pain ^a	M	56	1	13	0	0	0	0	1
	F	56	1	13	0	0	0	0	1

^aDistributions of costs and effectiveness assumed to be equal in M and F

Table 30.—Cost-Effectiveness Comparisons Across Population Subgroups^a

Population tested (by symptom)	Sex	Strategy							
		Δ C (\$000's)	A (test all)			Δ C (\$000's)	B (test threshold)		
			AE (TP)	ΔC AE (\$000's/TP)	Average cost/TP (\$000's)		AE (TP)	ΔC AE (\$000's/TP)	Average cost/TP (\$000's)
Nonischemic pain	F ^b				\$56.0	—	—	—	—
Nonischemic pain	M	\$21.0	4	\$5.2	15.4	—	—	—	—
Probable angina	F	21.0		1.5	5.2				\$5-2
Definite angina	F	24.0	35	0.7	2.3	\$24.0	35	\$0.7	2.3
Probable angina		9.0	-19		3.7	9	-20		3.7
Probable angina	M ^c	33.0	16	21	-	33	16	21	-
Definite angina	M	21.0	42	0.5	2.0	19	54	0.4	1.7

^aAssumption is made that the values of false-positive and false-negative results are inconsequential compared to true positives

^bCosts and effectiveness the same as in the no pain group for M and F

^cCompared t. probable angina in F.

to proceed to coronary arteriography. Cost estimates are affected accordingly (see table 29).

Cost effectiveness is examined both by marginal analysis and by average cost-effectiveness ratios (see table 30). Marginal analysis ranks population subgroups tested from least to most costly and calculates incremental costs and benefits relative to the next less costly subgroup. Such analysis shows that as one progresses from the testing of asymptomatic persons and females with nonischemic pain to subgroups with higher prevalence of surgically correctable coronary artery disease, incremental costs per true posi-

tive for both strategies A and B fall. Average cost-effectiveness ratios indicate a cost per true positive of no more than \$5,200 for patients with probable or definite angina, but a considerably higher ratio than this for patients with nonischemic pain or no pain (\$56,000 per true positive in females with nonischemic pain, in both sexes in the absence of pain). Clearly, the characteristics of the population tested have important implications for the cost effectiveness of diagnostic strategies. Cardiac imaging does not appear to be cost effective in the routine testing of asymptomatic patients or patients with atypical chest pain syndromes.

POLICY IMPLICATIONS

Cardiac radionuclide imaging is a new, rapidly expanding, and relatively expensive technology with the potential for extremely broad application in the diagnosis and evaluation of heart disease. The major challenges are to define the limits of its potential, to ensure proper use within those limits, and to maintain quality control. Physicians, the government, and third-party carriers all will need to participate in meeting these challenges.

Physicians are in the best position to define clinical indications and to ensure quality control. Since physicians stand to benefit monetarily and professionally from the performance of cardiac scans, however, they need to be counterbalanced by others who have a societywide perspective. Among the issues that require contributions from outside the medical profession are utilization control, prevention of possible low-dose radiation risks, and planning for future R&D.

Policy questions stimulated by the present study include the following:

1. Under what circumstances does cardiac imaging serve a useful role in cardiac diagnosis and evaluation, and what is the potential of cardiac imaging to obviate the need for other diagnostic modalities?
2. Should the diffusion of cardiac imaging capability be limited to hospitals with demonstrated nuclear medicine expertise, or should commercial laboratories and private practices perform scans?
3. Could certificate-of-need legislation be used to limit diffusion? Does scanning constitute a new service? Since cardiac imaging may be performed with existing equipment, it seems unlikely that the capital expenditure limit of the certificate-of-need legislation will be applicable except to positron emission tomography and new types of CAT equipment.
4. Should a group of experts be asked to define clinical indications for imaging? How would the standards be updated to accommodate improvements in the technology?
5. How could utilization be limited to these indications? Could reimbursement policies under Medicare and Medicaid be adapted to this end?
6. At present, there are wide differences in third-party reimbursement policies in different parts of the United States. Would standardization of policies and rates by Medicare/Medicaid and Blue Cross/Blue Shield be desirable? If the twofold discrepancy between the resource costs of scans and fee schedules were verified, should reimbursement schedules be adjusted?
7. How can safety in the use and disposal of radionuclides in cardiac imaging be assured?
8. How should the quality of laboratory results be monitored? Would a mechanism of quality control similar to that used by clinical chemistry laboratories be feasible?
9. Should R&D in new radionuclide imaging techniques be encouraged? With what objectives?
10. What further evaluation of the clinical effectiveness and cost effectiveness of radionuclide imaging needs be done? Should the use of scans by practicing physicians be monitored to document the effects on clinical decisions and patient benefits? Should the sensitivity and specificity of these techniques in population subgroups be further evaluated?
11. Would a National Institutes of Health consensus conference serve as a useful stimulus to develop policy concerning cardiac radionuclide imaging and to increase awareness of the medical profession of the benefits and limitations of imaging?

Most of these questions are generic ones that need to be addressed for any new technology and for many existing technologies, as well. Implementation of a uniform policy for evaluating medical technologies would serve, in the long run, to benefit the public and the medical profession alike.

APPENDIX A.—GLOSSARY OF TERMS

- Angina pectoris:** a condition characterized by severe transient chest pains, typically precipitated by exertion or excitement and relieved by rest.
- Arrhythmia:** any variation from the normal rhythm of the heart beat.
- Arteriography:** the radiologic (X-ray) visualization of the blood vessels following the injection of a contrast dye.
- Cardiac catheterization:** passage of a small catheter through a vein or artery into the heart for purposes of securing blood samples, determining intracardiac pressures, and detecting cardiac anomalies.
- Cardiac ejection fraction:** the amount of blood ejected during a heart beat.
- Cardiac radionuclide imaging:** the imaging of the heart by the detection of radioactivity in the heart muscle or heart chambers following the injection of a radionuclide or radiopharmaceutical.
- Coronary arteries:** arteries that supply blood to the heart.
- Coronary arteriography (coronary angiography):** arteriography of the coronary arteries.
- Coronary artery disease (coronary heart disease):** narrowing or blockage of the coronary arteries, usually which results in reduced blood flow to the heart muscle.
- Coronary artery bypass surgery:** a surgical procedure in which a vein or an artery is used to bypass a constricted portion of one or more coronary arteries. This procedure has become the primary surgical approach to the treatment of coronary artery disease.
- Echocardiography:** a method of imaging the heart walls and internal structures of the heart by the echo obtained from beams of ultrasonic waves directed through the heart wall.
- Effectiveness:** same as efficacy (see below) except that it refers to "average conditions of use."
- Efficacy:** benefit achieved in a defined population from a medical technology applied for a given medical problem under ideal conditions of use.
- Electrocardiogram (EKG):** a graphic tracing of the changes of electrical potential of the heart occurring during each heartbeat; usually performed with the patient supine and at rest.
- Exercise tolerance testing (exercise stress testing):** testing the response of the heart to exercise while observing the EKG and other physiological functions of the heart.
- Half-life:** the time required for the activity of a given quantity of radioactive material to decay to half its initial value.
- Infarct:** **an** area of necrosis (death) of tissue resulting from the obstruction of blood supply.
- Intracardiac shunt:** an abnormality of blood flow between the sides of the heart.
- Ischemia:** insufficient blood supply to meet the full physiologic needs of the tissue for oxygen (but short of the degree of ischemia that results in necrosis).
- Ischemic heart disease:** coronary artery disease of sufficient severity to result in angina pectoris or myocardial infarction.
- Myocardial infarction:** necrosis (death) of tissue in the myocardium (heart muscle) that results from insufficient blood supply to the heart. A transmural myocardial infarction involves the entire thickness of the myocardium, while a nontransmural infarction involves only part of the wall.
- Myocardium:** muscle of the heart.
- Nonischemic heart disease:** heart disease from causes other than coronary artery disease (e. g., congenital heart disease, rheumatic heart disease, myocardiopathy).
- Posterior probability of a disease:** the probability that a disease exists after the results of a given test are known.
- Prior probability of a disease:** the probability that a disease exists before the results of a given test are known.
- Radionuclide or radiopharmaceutical:** a radioactive substance.
- Radionuclide ventriculogram:** **an** image of the chambers (ventricles) of the heart obtained by detection of radioactivity following the injection of a radionuclide or radiopharmaceutical.
- Sensitivity of a diagnostic test:** proportion of all persons with a given disease whose tests results are positive (true-positive rate).
- Specificity of a diagnostic test:** proportion of all persons without a given disease whose results are negative (true-negative rate).
- Ventricle:** chamber of the heart.
- Ventricular angiogram:** a radiologic image of the ventricles of the heart obtained following the injection of a contrast dye.
- Ventriculography:** imaging of the ventricles of the heart.

APPENDIX B.—MANUFACTURERS OF CARDIAC RADIONUCLIDE IMAGING EQUIPMENT AND SUPPLIES

Picker Northford, Corm. (Head office in Cleveland, Ohio)

Background.—Picker is a subsidiary of CIT Corporation. It is one of the oldest companies in the nuclear medicine field and has produced gamma cameras since 1970.

Products.—Scintillation cameras, CAT scanner.
Current Models.—

	<i>Year introduced</i>	<i>List price</i>
DynaCamera 4/15-61 (15" field, 61 photomultiplier tubes, scintillation camera)	1979	\$110,000+
DynaCamera 4 15-37 (15" field, 37 tubes, scintillation camera)	1976	\$96,000-100,000 +
DynaCamera 4/11-37 (11" field, 37 tubes, scintillation camera)	1976	\$90,000
DynaMO (motorized mobile scintillation camera, a 4/11-37 on wheels)	1976?	\$100,000 avg.
DynaCamera 4 (19 tubes)	1974	Discontinued

Market Share.—Claims independent survey of June 1978 to June 1979 sales of scintillation cameras gives Picker 35- to 38-percent market share and first-place ranking.

Customers.—1) Hospitals (ranked: radiology, nuclear medicine, pathology, internal medicine, cardiology); and 2) physicians' offices.

Sales Strategy.—Company prefers to be conservative and tries to maximize the number of standard features, while minimizing add-on accessories. Emphasis on quality control in production raises cost of products. Sales from network of 1 national, 4 regional, and 120 district offices. Advertisements are aimed at physicians. Works with major computer manufacturers to maximize ease of interface.

Future Directions for Company.—In 1979, introduced 7-pin-hole tomography with 4/15-61 camera. Predicts that future products will be less expensive, yet will offer better resolution scans. Also researching positron emission tomography, but unsure of economic feasibility.

Future Directions for Radionuclide Imaging.—Features will include higher performance digital computers, better resolution and lower cost. Emphasis will be on improving resolution and sensitivity, better service, and lower price in that order. Respondent sees organizational trend in hospitals toward departments of medical imaging to consolidate administratively nuclear medicine, X-ray, ultrasound, CAT scanning, and other imaging technologies.

General Electric (GE) Waukesha, Wis.

Background.—GE entered the nuclear medicine field in 1972 as a distributor for the Elscint whole-body scanner. In 1975, it bought Nuclear Data, which had just developed the first mobile scintillation camera.

Products.—Scintillation cameras.
Current Models.—

	<i>Year introduced</i>	<i>List price</i>
MaxiCamera 2 System (large-field (16") scintillation camera system, 37 tubes)	1978	\$80,000-\$120,000
MaxiCamera 535 (large-field (24") scintillation camera, 64 tubes)	1978?	?
MaxiCamera 400T (large-field (24") scintillation camera, 67 tubes, for 7-pin-hole tomography)	1979?	?
DataCamera (motor-powered, small-field mobile camera, 37 tubes)	1977	\$80,000-\$120,000
PortaCamera 2C (manually moved, small-field mobile scintillation camera, 37 tubes)	1977?	\$65,000
(MaxiCamera 1)	1977	Discontinued
(MaxiCamera)	1976	Discontinued

Market Share.—Claimed 26 percent of scintillation camera market in fiscal year 1978.

Customers.—1) Hospitals (ranked: nuclear medicine, radiology, internal medicine, cardiology); and 2) physicians' offices.

Sales Strategy.—Broad range of models, including PortaCamera 2C for the "van trade" (physicians and technologists who bring the cameras in vans to remote hospitals). Field sales force includes 20 nuclear medicine specialists and 300 X-ray salesmen. Advertising is aimed at physicians through professional journals and medical conventions.

Future Directions for Company.—GE is developing single-photon emission tomography and positron emission tomography equipment.

Future Directions for Radionuclide Imaging.—Respondent foresees more expensive equipment, especially more sophisticated computers. Scintillation cameras will become digital solid-state detectors. Trend toward positron emission tomography and the assessment of cardiac metabolism. Sees organizational trend toward hospital departments of diagnostic imaging, consolidating all imaging functions.

Searle Radiographic 2000 Nuclear Drive Des Plaines, Ill.

Background.—Searle was formed when G. D. Searle, a pharmaceutical manufacturer, bought Nuclear Chicago in the 1960's. First company to manufacture scintillation cameras. Still appears to have largest installed base and largest market share.

Products.—Scintillation cameras, minicomputer, CAT scanner.

Current Models.—

	Year introduced	List price
Pho/Gamma 5 (scintillation camera system)	1977	\$78,000- \$150,000
Scintiview (microprocessor) - Gamma/COR (cardiac probe)	1977	\$49,000 \$15,000
Pho/Gamma LFOV (large-field-of-view scintillation camera)	1976	\$90,000 (avg. depending on collimator(s))
Pho/Gamma LEM (low energy, mobile scintillation camera)	1976	\$85,000 (\$106,500 w/ADAC computer)
Pho/Con-Emission Tomographic Scanner	1975 (updated 1979)	?
Pho/Gamma 37 GP Camera (update)	1974	?

Market Share.—Claimed 1978 market share of 46 percent for scintillation cameras.

Customers.—1) Hospitals (ranked: radiology, internal medicine, pathology, cardiology); 2) clinics; 3) physicians' offices; and 4) commercial laboratories.

Sales Strategy.—Company prefers to wait and introduce well-developed equipment, not to do continual updates. Uses direct sales from main office. Advertising aimed at doctors through professional and trade journals and medical conventions.

Future Directions for Company.—Currently developing lines of single-photon and positron emission tomography in Europe, where cost regulation is said to be less than in the United States. Conducting research on solid-state crystals for photon detection.

Future Directions for Radionuclide Imaging.—Cardiac imaging will continue to increase, especially techniques using technetium. Thallium use will also increase, but more slowly because it is too expensive. Positron emission tomography will increase greatly if prices drop or Government cost controls ease. Respondent sees trend toward easier to use, less expensive equipment.

Ohio Nuclear 29100 Aurora Road Solon, Ohio 44139

Background.—*

Products.—Scintillation cameras, minicomputer, CAT scanner.

Current Models.—

	Year introduced	List price
Sigma 400 Camera (standard field of view)	?	?
Sigma 4105 Camera (large field of view)	?	\$85,000- \$100,000
Sigma 420 Mobile Camera	?	\$125,000

Market Share.—Outside estimate of 1978 market share is 20 to 25 percent (scintillation cameras and systems). Inside estimate is that Ohio Nuclear has two-thirds of the mobile camera market; 122 units sold in fiscal year 1979. Picker and Searle are the competition for mobile cameras. For fixed cameras, Ohio Nuclear has 15 percent of the market.

Customers.—1) Hospitals.

Sales Strategy.—Push mobile cameras. The "Moon Buggy" is the most mobile and reliable mobile unit and is battery powered. Ohio Nuclear software is better than ADAC.

Future Directions for Company.—

Future Directions for Radionuclide Imaging.—Efficiency and resolution of cameras will be improved twofold to threefold.

Raytheon 70 Ryan Street Stamford, Conn. 06907

Background.—Raytheon is a large corporation that appears to be about the fifth largest scintillation camera manufacturer.

Products.—Scintillation cameras, minicomputer.

Current Models.—

	Year introduced	List price
Step 1 (scintillation camera)	1978	Step 1 and
Step 2 (formatter/microprocessor/CRT)	1978	Step 2
		together sell for \$100,000 to \$115,000
XL 91 (large-field-of-view scintillation camera)	1976	

Market Share.—Proprietary.

*Data Incomplete No literature received from company

Customers.—1) Hospitals (ranked: radiology, cardiology); and 2) physicians' offices (only a few radiologists and cardiologists).

Sales Strategy.—Company uses its own field sales force. Advertising is aimed at physicians through professional and trade journals and through business magazines.

Future Directions for Company.—Future products will be more dedicated to specific cardiac imaging uses and less general purpose.

Future Directions for Radionuclide Imaging.—Respondent feels market for cardiac imaging is "growing by leaps and bounds." Sees future products easier to use, less expensive to purchase, less expensive to operate, and more dedicated to thallium and technetium cardiac studies.

**Baird Corp.
Cordis Nuclear Medical Systems
125 Middlesex Turnpike
Bedford, Mass. 01730**

Background.—Baird was the second company to manufacture scintillation cameras (beginning in 1965) and an early developer of the multicrystal camera (about 1972). Company has not been able to capitalize on the market share advantage provided by its early entry into the field. There are 100 systems in the field at present, but only 12 were sold in 1978.

Products.—Scintillation camera system,

Current Models.—

	<i>Year introduced</i>	<i>List price</i>
System 77 (scintillation camera system with Keronix computer)	1972	\$99,500- \$190,000

Market Share.—Proprietary. Only producer of multicrystal camera for "first-pass" studies.

Customers.—Hospitals (ranked: radiology, nuclear medicine)

Sales Strategy.—Refined single model distributed by Cordis.

Future Directions for Company.—Will continue to produce the System 77 with updates.

Future Directions for Radionuclide Imaging.—Opinion not expressed.

**Union Carbide
Medical Imaging Division
333 Providence Highway
Norward, Mass. 02062**

Background.—Union Carbide is a large corporation that entered the nuclear medicine field in 1976

when it purchased Cleon, a company that had just developed a CAT scanner.

Products.—Scintillation camera, minicomputer, single-photon tomographic imager.

Current Models.—

	<i>Year introduced</i>	<i>List price</i>
Union Carbide Cleon 711 (radionuclide body function imager for single-photon tomography)	1979	\$398,000
Union Carbide Cleon 720 (large-field gamma camera)	1977	\$70,000
Union Carbide Cleon 110 (image processor, minicomputer)	1977	\$50,000

Market Share.—Proprietary, but claims Union Carbide is in fifth place in scintillation camera and systems sales.

Customers.—1) Hospitals (ranked: nuclear medicine, radiology); 2) physicians' offices (few); and 3) clinics (few).

Sales Strategy.—Union Carbide uses its own regionally based sales force. Advertising is aimed at physicians through professional trade journals and meetings.

Future Directions for Company.—Into single-photon tomography market. Will continue research and explore new markets.

Future Directions for Radionuclide Imaging.—There will be new capabilities in cardiac imaging, especially from improved data processing. Resolution of scans will not increase much, as cameras are operating at their limits of resolution (about 1/10") now. The Anger-type scintillation camera will continue in use for about 5 years. The present market is mature, with stable prices through competition and comparable products. The use of CAT scanning in cardiac diagnosis will increase during the next 5 years.

**ADAC (Analytical Development
Associates Corp.) Laboratories
255 San Geronimo Way
Sunnyvale, Calif. 94086**

Background.—ADAC Laboratories is a California company that has been manufacturing computers for medical use since the mid-1970's. ADAC is perhaps the leader in computers for nuclear cardiology.

Products.—Minicomputers for nuclear imaging.

Current Models.—

	<i>Year introduced</i>	<i>List price</i>
Clinical Acquisition Module 11 ? (mobile minicomputer for		\$40,000 (base)

imaging data collection and manipulation)		\$50,000 (avg.)
Clinical Acquisition Module (mobile minicomputer for imaging data collection)	1976?	
Clinical Data System (stationary minicomputer)	1976	\$50,000 (base) \$75,000 (avg.)

Also: a Remote Terminal, a Modem to transmit data over telephone lines, a Multiformat Camera to transfer images or curves to X-ray film, a high-speed Disk Drive, a Fortran IV compiler on which users can write their own software, and a number of software packages including 7-pinhole tomography.

Market Share.—Proprietary, but claims to and appears to be ranked first in sales for minicomputers, though may be tied with Medical Data Systems.

Customers.—1) Hospitals (ranked: radiology and cardiology); and 2) private radiology and cardiology laboratories and practices.

Sales Strategy.—Not described. Company advertises in professional journals and at conventions.

Future Directions for Company.—Continue research. Nuclear cardiology is company's biggest application. Developing software for 7-pinhole tomography. Also developing software for 7-pinhole gated blood pool tomography.

Future Directions for Radionuclide Imaging.—Not discussed.

Medical Data Systems (MDS) Division of Medronic, Inc. 2311 Green Road Ann Arbor, Mich. 48105

Background.—MDS is an established leader in the computer segment that maintains its software capabilities are second to none. The company pioneered MUGA (multiple-gated-acquisition) studies.

Products.—Computer systems.

Current Models.—

	Year introduced	List price
Modumed	1972	
Az	1972	\$53,000

Market Share.—400 Modumed systems in the field, and 60 Az units sold since January 1979. Has production problems and a current 90- to 120-day delay in meeting orders. Major competition is ADAC. Virtues of the Az model include a hard disc and minicomputer (versus ADAC's floppy disc and microprocessor) and the ability to acquire and process more than one study simultaneously.

Customers.—1) Hospitals; and 2) physicians' offices.

Future Directions for Company.—Improved software and trend toward larger central processing units.

Digital Equipment Marlborough, Mass.

Background.—Digital Equipment is a large minicomputer firm producing computers for nuclear medicine applications.

Products.—Minicomputers for nuclear medicine data applications.

Current Models.—

	Year introduced	List price
Gamma 11-1134 Processor* (minicomputer for use with scintillation cameras)	1976	\$54,000
MDA-11 (mobile unit)	?	?

* Includes 128 Kiloword memory, DEC terminal, video terminal, Anger camera interface color video ability, operating system, software, installation, operator training, 90-day's service.

Market Share.—Proprietary, but claims to be leader in nuclear medicine computers worldwide, with more than 500 systems installed, many in research institutions.

Customers.—1) Hospitals (ranked: radiology, nuclear medicine, cardiology); and 2) clinics.

Sales Strategy.—Not discussed. Advertisements in professional journals aimed at physicians.

Future Directions for Company.—Continued research to develop hardware and software for present and new cardiac imaging technologies.

Future Directions for Radionuclide Imaging.—Respondent sees two diverging trends in hardware: 1) use of large central computers to process input from one or more small remote computers; and 2) increasing use of portable self-contained units. Thinks future belongs to tomography, but not sure which tomographic technique. Seven-pinhole is the easiest to perform, but the new revolving-head cameras for radionuclide tomography (Searle Pho/Con, GE, Union Carbide) will compete.

Mallinckrodt Nuclear 675 Brown Road Hazelwood, Mi. 63042

Background.—Mallinckrodt is a large chemical producer that has been involved in nuclear medicine for many years. The company sold contrast media before buying Nuclear Consultants in about 1965. It then started making and selling its own line of radiochemicals.

Products.—Technetium generators, gallium, thallium (introduction imminent), cold mix agents.

Current Models.—

	<i>Year introduced</i>	<i>List price</i>
Ultratechnical Tc99m Generator (in 8 steps of increasing radiation specific activity from 250 mCi to 3 Ci)	1965	\$160-\$500 (depending on specific activity)
Techniscan (pyrophosphate cold mix)		\$71 .50/kit
Gallium generators		

Market Share.—Proprietary. Respondent claims Mallinckrodt and Squibb are tied for first place in sales of technetium generators and that Mallinckrodt sells over 1,000 generators per week, Mallinckrodt is first overall in radiopharmaceuticals.

Customers.—Hospitals (ranked: radiology, nuclear medicine).

Sales Strategy.—Not discussed. Advertisements are aimed at physicians through professional journals.

Future Directions for Company.—Mallinckrodt will soon introduce thallium and a kit to determine cardiac enzyme (CPK) levels to diagnose acute myocardial infarctions. Thallium will probably be produced in Holland initially and transported to distribution centers in the United States.

Future Directions for Radionuclide Imaging.—Not discussed.

**Squibb
Hospital Division
P.O. Box 4000
Princeton, N. J. 08540**

Background.—Squibb is a large pharmaceutical firm that has produced radionuclides since about 1963.

Products.—Technetium generators, cold mixes.

Current Models.—

	<i>Year introduced</i>	<i>List price</i>
Technethium-99m Molybdenum Generator (in 6 steps of increasing radiation specific activity from 220 mCi to 2.2 Ci)	1963	\$100-\$300 (depending on specific activity)
Phosphotec (pyrophosphate for labeling with Tc-99m)		
Macrotec (albumin for labeling with Tc-99m)		

Market Share.—Respondent claims Squibb is leader in generator and cold mix sales, with 50 percent of the market.

Customers.—1) Hospitals (ranked: radiology, cardiology, pathology, internal medicine); and 2) physicians' offices (radiologists, cardiologists).

Sales Strategy.—Squibb employs its own field sales force. Production facilities are on both coasts of the United States, in New Brunswick, N. J., and in Los Angeles, Calif. Advertising is aimed at physicians and hospital administrators in medical, professional, and trade journals.

Future Directions for Company.—Seeking approval to introduce thallium.

Future Directions for Radionuclide Imaging.—Market is still growing. Respondent thinks technetium will replace the cyclotron-produced thallium, as it replaced cyclotron-produced fluoride in bone imaging. Reasons are the lower cost and lower radiation dose of technetium compared to thallium.

**New England Nuclear (N EN)
Medical Diagnostics Division
Bedford, Mass.**

Background.—NEN has been a producer of isotopes and radiopharmaceuticals since 1956. The company owns four cyclotrons and is the sole source of thallium approved for human use in the United States.

Products.—Thallium, technetium generators, cold mixes, other radioisotopes.

Current Models.—

	<i>Year introduced</i>	<i>List price</i>
Thallous Chloride-201 (1.65 mCi, thallium for cardiac scanning)	1977	\$93.50 (dose)
Technetium Generator (in 8 steps of increasing radiation specific activity from 225 mCi to 2.7 Ci)	1967	\$169-\$776 (depending on amount)
Pyrolite ("hot spot" imaging agent for labeling with technetium)	1977?	\$483 (30 vials)
Cardiolite (human serum albumin imaging agent for labeling with technetium; not FDA approved for human use)	1977?	—

Market Share.—100 percent of market for thallium (sole U.S. source). Respondent claims that NEN is even with Mallinckrodt and Squibb in technetium generator sales, with each company having one-third of the market. In cardiac cold kits, these companies are all tied for second position behind Union Carbide.

Customers.—1) Hospitals (ranked: radiology, internal medicine, cardiology, pathology); and 2) physicians' offices (increasing).

Sales Strategy.—NEN employs an international field sales force in the United States, Japan, South America, Europe, India. Salespersons coordinate cardiologists and nuclear medicine specialists with the supplier. Advertising in professional journals and at conventions.

Future Directions for Company .—NEN is evaluating radionuclides with improved energy characteristics and reduced radiation dose.

Future Directions for Radionuclide Imaging.—Respondent predicts considerable growth in use of thallium for the next years. Predicts considerable future use of positron emission tomography due to its desirable scanning characteristics and reduced radiation dose. Active research into development of new isotopes with long-lived parents and short-lived (1 to 30 minutes) products of appropriate energy.

Medi + Physics (a subsidiary of Roche Pharmaceuticals) Emeryville, Calif.

This company markets "instant technetium," a ready-to-use form for labeling cold mix imaging agents. The 6-hour half-life of the isotope necessitates same-day delivery to users. This form is popular on the west coast, where it is provided by Medi + Physics and a number of smaller radiopharmacies.

Procter and Gamble Cincinnati, Ohio

This company manufactures one product for use in radionuclide scanning, "Osteoscan," a cold mix agent used for bone imaging but also approved for "hot spot" myocardial infarction imaging.

Union Carbide Clinical Diagnostics Division Tuxedo, N.Y.

Background.—Union Carbide is a large, diversified chemical company that was able to enter the radionuclide market through possession of a reactor for economic production.

Products.—Technetium generators, cold imaging agents.

Current Models.—

	<i>Year introduced</i>	<i>List price</i>
CintiChem Moly-99m- Technetium-99m Generator (in 5 steps of increasing radiation	1972	\$180-\$360 (depending on amount)

specific activity from 500 mCi
to 2.5 Ci)

CintiChem HSA (human serum 1972
albumin imaging agent for
labeling with technetium)

Market Share.—Respondent states that Union Carbide is ranked third in sales of technetium generators (after Mallinckrodt and New England Nuclear) with 20 percent of the market.

Customers.—1) Hospitals (ranked: radiology); 2) physicians' offices (a few radiologists); 3) clinics (radiologists); and 4) radiopharmacies.

Sales Strategy.—Union Carbide employs its own field sales force from regional offices, and orders can be made directly to the main office as well. Advertising is aimed at physicians through professional journals and at conventions.

Future Directions for Company .—Not discussed.

Future Directions for Radionuclide Imaging.—Not discussed.

Ancillary Equipment Producers

The following three companies are included to describe the range of products in this segment. They are not intended to be a representative sample of the hundreds of ancillary equipment producers.

**Harshaw Chemical Company
Crystal and Electronic Products
Division
6801 Cochran Road
Solon, Ohio 44139**

This company is a manufacturer of components for scintillation cameras. It produces the detectors and sells them to the camera producers. Its main customer is Searle; companies in the second rank of Harshaw clients are Picker, Pfizer, Ohio Nuclear, GE, and Raytheon. The company began producing scanner parts in 1955-60. Respondent considers that radionuclide imaging in the future will be characterized by equipment that is more technician-oriented, easier to use, capable of faster scans with better resolution, and exposes the patient to a lower whole-body radiation dose.

**Med-X, Inc.
Palatine, Ill.**

This company specializes in servicing and upgrading older Searle scintillation cameras. It makes and installs two models of improved detectors, the X-7 and the X-37 Super Resolution. These detectors improve resolution from 3/16" to about 1/10" or better.

The new detectors cost from \$19,000 to \$25,000, including 1 year of service. Meal-X was started by former Searle employees and has been making updates since 1975. The firm's largest customers are hospital purchasers of used scintillation cameras. Meal-X also performs scanning for rural hospitals on a per-scan charge basis. The respondent predicts that the future of medical imaging will be a competition among competing modalities, with scanning, ultrasound, and other technologies all improving constantly.

**Eastman Kodak
Health Sciences Division
State Street
Rochester, N.Y.**

This large photographic and chemical company makes X-ray and other sheet film to produce the hard copy of selected images from cardiac radionuclide studies. From one to many pictures up to 8" x 10" may be taken during each study for viewing by physicians and/or for the patient's record.

REFERENCES

1. Bailey, I. K., et al., "Thallium-201 Myocardial Perfusion Imaging at Rest and During Exercise," *Circulation* 55:79, 1977.
2. Berger, B. C., et al., "Redistribution of Thallium at Rest in Patients With Stable and Unstable Angina and The Effect of Coronary Artery Bypass Surgery," *Circulation* 60:1114, 1979.
3. Berger, H. J., et al., "Dual Radionuclide Study of Acute Myocardial Infarction: Comparison of Thallium-201 and Technetium-99m Stannous Pyrophosphate Imaging in Man, " *Ann. Int. Med.* 88:145, 1978.
4. Blood, D. K., et al., "Comparison of Single-Dose and Double-Dose Thallium-201 Myocardial Perfusion Scintigraphy for the Detection of Coronary Artery Disease and Prior Myocardial Infarction," *Circulation* 58:777, 1978.
5. Blumgart, H. C., and Weiss, S., "Studies on the Velocity of Blood Flow, VII: The Pulmonary Circulation Times in Normal Resting Individuals, " *J. Clin. Inv.* 4:399, 1927.
6. Bodenheimer, M. M., et al., "Comparative Sensitivity of the Exercise Electrocardiogram, Thallium Imaging, and Stress Radionuclide Angiography To Detect the Presence and Severity of Coronary Artery Disease, " *Circulation* 60:1270, 1979.
7. _____, "Detection of Coronary Heart Disease Using Radionuclide Determined Regional Ejection Fraction at Rest and During Handgrip Exercise: Correlation With Coronary Arteriography," *Circulation* 58:640, 1978.
8. _____, "Extent and Severity of Coronary Heart Disease: Determinations by Thallous Chloride Tl-201 Myocardial Perfusion Scanning and Comparison With Stress Electro Cardiography," *Arch. Int. Med.* 139:630, 1979.
9. _____ "Quantitative Radionuclide Angiography in the Right Anterior Oblique View: Comparison With Contrast Ventriculography," *Am. J. Card.* 41:718, 1978.
10. Bonte, F. J., et al., "A New Method for Radionuclide Imaging of Myocardial Infarcts, " *Radio.* 110:473, 1974.
11. Borer, J. S., et al., "Real-Time Radionuclide Cineangiography in the Non-Invasive Evaluation of Global and Regional Left Ventricular Function at Rest and During Exercise in Patients With Coronary Artery Disease, " *N. Eng. J. Med.* 296:839, 1977.
12. _____, "Sensitivity, Specificity, and Predictive Accuracy of Radionuclide Cineangiography During Exercise in Patients With Coronary Artery Disease," *Circulation* 60:572, 1979.
13. Botvinick, E. H., et al., "Thallium-201 Myocardial Perfusion Scintigraphy for the Clinical Clarification of Normal, Abnormal and Equivocal Electro Cardiographic Stress Tests," *Am. J. Card.* 41:43, 1978.
14. Burow, R. D., et al., "Analysis of Left Ventricular Function From Multiple-Gated Acquisition Cardiac Blood Pool Imaging: Comparison to Contrast Angiography," *Circulation* 56:1024, 1977.
15. Caldwell, J. H., et al., "Comparative Sensitivity and Specificity of Exercise Radionuclide Ventriculography and Rest-Exercise Thallium Imaging in the Detection of Coronary Artery Disease, " *J. Nucl. Med.* 20:687, 1979.
16. Carr, E. A., Jr., et al., "The Detection of Experimental Myocardial Infarction by Photoscanning," *Am. Heart J.* 64:650, 1962.
17. _____ "Evaluation of 203 Hg-Chlormerodrin in the Demonstration of Human Myocardial Infarcts by Scanning, " *U. Mich. Med. Bull.* 29:27, 1963.
18. Carrillo, A. D., et al., "Correlation of Exercise 201-Thallium Myocardial Scan With Coronary Arteriograms and the Maximal Exercise Test," *Chest* 73:321, 1978.
19. Chaitman, B. R., et al., "The Importance of Clinical Subsets in Interpreting Maximal Treadmill Exercise Test Results: The Role of Multiple-Lead ECG Systems," *Circulation* 59:560, 1979.
20. Diamond, G. A., and Forrester, J. S., "Analysis of Probability as an Aid in the Clinical Diagnosis of Coronary Artery Disease, " *N. Eng. J. Med.* 300:1350, 1979.
21. F. Eberstadt & Co, Inc., "Nuclear Scanning, Computer Systems, and Informatek, " Aug. 17, 1978.
22. Federman, J., et al., "Multiple-Gated Acquisition Cardiac Blood-Pool Isotope Imaging: Evaluation of Left Ventricular Function Correlated With Contrast Angiography," *Mayo Clin. P.* 53:625, 1978.
23. Folland, E. D., et al., "The Radionuclide Ejection Fraction: A Comparison of Three Radionuclide Techniques With Contrast Angiography," *J. Nucl. Med.* 18:1159, 1977.
24. Goldman, L., et al., "Assessment of the Ordering and Impact of Cardiac Nuclear Studies, " *Clin. Res.* 27(2) 221A, 1979.
25. Gould, K. L., et al., "Noninvasive Assessment of Coronary Stenoses With Myocardial Perfusion Imaging During Pharmacologic Coronary Vasodilation," *Am. J. Card.* 43:200, 1979
26. Greenberg, B. H., et al., "Thallium-201 Myocar-

- dial Perfusion Scintigraphy To Evaluate Patients After Coronary Bypass Surgery, " *Am. J. Card.* 42:167, 1978.
27. Guthaner, D. F., et al., "CT Demonstration of Cardiac Structures, " *Am. J. Roentg.* 133:75, 1979.
 28. Hoiland-Carlson, P. E., et al., "The Predictive Value of Myocardial Scintigraphy With 99m-Tc Pyrophosphate in Diagnosing Acute Myocardial Infarction, " *Acta Med. Scand.* (% ppl.) 623:55, 1978.
 29. Holman, B. L., et al., "Detection and Sizing of Acute Myocardial Infarcts With 99m-Tc (Sri) Tetracycline, " *N. Eng. J. Med.*, 291:159, 1974.
 30. _____, "Myocardial Scintigraphy With Technetium-99m Pyrophosphate During the Early Phase of Acute Infarction, " *Am. J. Card.* 41:39, 1978.
 31. _____, "The Prognostic Implications of Acute Myocardial Infarct Scintigraphy With 99m-Tc Pyrophosphate, " *Circulation* 57:320, 1978.
 32. _____ "Single-Photon Transaxial Emission Computed Tomography of the Heart in Normal Subjects and in Patients With Infarction, " *J. Nucl. Med.* 20:736, 1979.
 33. Klausner, S. C., et al., "The Application of Radionuclide Infarct Scintigraphy To Diagnose Perioperative Myocardial Infarction Following Revascularization, " *Circulation* 56:173, 1977.
 34. Lenears, A., et al., "Segmental Analysis of Tl-201 Stress Myocardial Scintigraphy, " *J. Nucl. Med.* 18:509, 1977.
 35. Leppo, J., et al., "Thallium-201 Myocardial Scintigraphy in Patients With Triple-Vessel Disease and Ischemic Exercise Stress Tests, " *Circulation* 59:714, 1979.
 36. Losse, B., et al., "Exercise Thallium-201 Myocardial Perfusion Imaging in Patients With Normal Coronary Angiogram and Ventriculogram, " *Circulation* 59-60 (Suppl. II):148, 1979.
 37. Love, W. D., et al., "A Comparison of the Distribution of Potassium and Exchangeable Rubidium in the Organs of Dogs, Using Rubidium-86, " *Cir. Res.* 2:112, 1954.
 38. Lowenthal, I. S., et al., "Diagnosis of Acute Myocardial Infarction in Patients Undergoing Open Heart Surgery: A Comparison of Serial Myocardial Imaging With Cardiac Enzymes, Electro Cardiography, and Vector Cardiography, " *J. Nucl. Med.* 18:770, 1977
 39. Maddox, D. E., et al., "Regional Ejection Fraction: A Quantitative Radionuclide Index of Regional Left Ventricular Performance, " *Circulation* 59:1001, 1979,
 40. Malek, P., et al., "Fluorescence of Tetracycline Analogs Fixed in Myocardial Infarction, " *Card.* 42:303, 1963.
 41. Malin, F. R., et al., "Sequential Myocardial Scintigraphy With Technetium-99m Stannous Pyrophosphate Following Myocardial Infarction, " *J. Nucl. Med.* 19:1111, 1978.
 42. Marshall, R. C., et al., "Assessment of Cardiac Performance With Quantitative Radionuclide Angiography, " *Circulation* 56:820, 1977.
 43. Massie, B. M., et al., "Correlations of Thallium-201 Scintigrams With Coronary Anatomy: Factors Affecting Region-by-Region Sensitivity, " *Am. J. Card.* 44:616, 1979.
 44. _____, "Myocardial Scintigraphy With Technetium-99m Stannous Pyrophosphate: An Insensitive Test for Non-Transmural Myocardial Infarction, " *Am. J. Card.* 43:186, 1979.
 45. McCarthy, D. M., et al., "Single Dose Myocardial Perfusion Imaging With Thallium-201: Application in Patients With Non-Diagnostic Electro Cardiographic Stress Tests, " *Am. J. Card.* 43:899, 1979.
 46. McNeil, B. J., et al., "Primer on Certain Elements of Medical Decision-Making, " *N. Eng. J. Med.* 293:211, 1975.
 47. Meller, J., et al., "Spectrum of Exercise Thallium-201 Myocardial Perfusion Imaging in Patients With Chest Pain and Normal Angiograms, " *Am. J. Card.* 43:717, 1979.
 48. Moran, A. D., "Reducing Hospital Clinical Laboratory Costs Through Increased Outpatients Testing, " *Hosp. Prog.* February 1975.
 49. Mullins, C. B., et al., "Determination of Ventricular Volume by Radioisotope Angiography, " *Am. J. Card.* 24:72, 1969.
 50. National Center for Health Statistics, Hyattsville, Md., personal communication, 1979.
 51. National Center for Health Statistics, "1976 Summary: National Ambulatory Medical Care Survey: Advance Data, " in *Vital and Health Statistics*, series 30 (Hyattsville, Md.: NCHS, 1978).
 52. _____, "Prevalence of Chronic Circulatory Conditions, United States, 1972, " in *Vital and Health Statistics*, series 10, no. 94 (Hyattsville, Md.: NCHS, 1974).
 53. Nichols, A. B., et al., "Clinical Utility of Gated Cardiac Blood Pool Imaging in Congestive Heart Failure, " *Am. J. Med.* 65:785, 1978.
 54. Okada, R. D., et al., "Clinical Value of the Thallium-201 Stress Test Sensitivity and Specificity in the Detection of Coronary Artery Disease, " *Int. J. Nucl. M.* 5:211, 1978.
 55. _____ "Observer Variance in the Quantitative Evaluation of Left Ventricular Wall Motion and the Quantitation of Left Ventricular Ejection Fraction Using Rest and Exercise Multigated Blood Pool Imaging, " *Circulation* 61:128, 1980.
 56. Parkey, R. W., et al., "A New Method for Radio-

- nuclide Imaging of Acute Myocardial Infarction in Humans," *Circulation* 50:540, 1974.
57. Pohost, G. M., et al., "The Thallium Stress Test: The Qualitative Approach Revisited," *Circulation* 60:149, 1979.
 58. Poliner, L. R., et al., "Clinicopathologic Findings in 52 Patients Studied by Technetium-99m Stannous Pyrophosphate Myocardial Scintigraphy," *Circulation* 59:257, 1979.
 59. Professional Activities Survey, Chicago, Ill., personal communication, 1979.
 60. Public Health Service, *Facts of Life and Death*, DHEW Publication No. (PHS) 79-1222 (Washington, D. C.: DHEW, 1978).
 61. Reduto, L. A., "Correlation of Left Ventricular Ejection Fraction Determined by Radionuclide Techniques and Angiography," *Gamma News* 2:1, 1979.
 62. Renaud, L., et al., "Fourier Multiaperture Emission Tomography," *JWM* 20:986, 1979.
 63. Rerych, S. K., et al., "Cardiac Function at Rest and During Exercise in Normals and Patients With Coronary Heart Disease: Evaluation by Radionuclide Angiocardigraphy," *Ann. Surg.* 187:449, 1978.
 64. Ritchie, J. L., et al., "Myocardial Imaging With Thallium-201 at Rest," *Circulation* 56:66, 1977.
 65. _____ "Thallium-201 Myocardial Imaging Before and After Coronary Revascularization," *Circulation* 56:830, 1977.
 66. Roberts, A. L., et al., "Perioperative Myocardial Infarction Associated With Coronary Artery Bypass Graft Surgery: Improved Sensitivity in the Diagnosis Within Six Hours After Operation With Tc-99m Glucoheptonate Myocardial Imaging and Myocardial-Specific Enzymes," *Ann. Thorac. Surg.* 27:42, 1979.
 67. Robinson, P. S., et al., "Thallium-201 Myocardial Imaging in Assessment of Aorto Coronary Bypass Surgery," *Br. Heart J.* 42:455, 1979.
 68. Schelbert, H. R., et al., "Non-Traumatic Determination of Left Ventricular Ejection Fraction by Radionuclide Angiography," *Circulation* 52:902, 1975.
 69. Sharpe, D. N., et al., "The Clinical Estimation of Acute Myocardial Infarct Size With 99m-Technetium Pyrophosphate Scintigraphy," *Circulation* 57:307, 1978.
 70. Siemers, P. T., et al., "Detection, Quantitation, and Contrast Enhancement of Myocardial Infarction Utilizing Computerized Axial Tomography: Comparison With Histo-Chemical Staining and 99m-Tc Pyrophosphate Imaging," *Inv. Radio/.* 13:103, 1978.
 71. Slutsky, R., et al., "Assessment of Early Ventricular Systole by First Pass Radionuclide Angiography: Useful Method for Detection of Left Ventricular Dysfunction at Rest in Patients With Coronary Artery Disease," *Am. J. Card.* 44:459, 1979.
 72. Sobel, B. E., et al., "Detection of Remote Myocardial Infarction in Patients With Positron Emission Transaxial Tomography and Intravenous IIC-Palpitae," *Circulation* 55:853, 1977.
 73. Sonnemaker, R. E., et al., "Single Injection Thallium-201 Stress and Redistribution Myocardial Perfusion Imaging: Comparison With Stress Electro Cardiography and Coronary Arteriography," *Radio.* 131:199, 1979.
 74. Stolzenberg, J., and London, R., "Reliability of Stress Thallium-201 Scanning in the Clinical Evaluation of Coronary Artery Disease," *Clin. Nucl. Med.* 4:225, 1979.
 75. Strauss, H. W., et al., "A Scintiphotographic Method for Measuring Left Ventricular Ejection Fraction in Man Without Cardiac Catheterization," *Am. J. Card.* 28:575, 1971.
 76. Turner, D. A., et al., "The Predictive Value of Myocardial Perfusion Scintigraphy After Stress in Patients Without Previous Myocardial Infarction," *J. Nucl. Med.* 19:249, 1978.
 77. Vecchio, J. J., "Predictive Value of a Single Diagnostic Test in Unselected Populations," *N. Eng. J. Med.* 274:1171, 1966.
 78. Veroni, M. S., et al., "Sensitivity and Specificity of Thallium-201 Perfusion Scintigrams Under Exercise in the Diagnosis of Coronary Artery Disease," *J. Nucl. Med.* 19:773, 1978.
 79. _____ "Thallium-201 Myocardial Scintigrams in the Evaluation of Aorto-Coronary Saphenous Bypass Surgery," *J. Nucl. Med.* 19:765, 1978.
 80. Vogel, R. A., et al., "A New Method of Multiplanar Emission Tomography Using a Seven-Pinhole Collimator and an Angioscintillation Camera," *J. Nucl. Med.* 19:648, 1978.
 81. _____, "Thallium-201 Myocardial Perfusion Scintigraphy: Results of Standard and Multi-Pinhole Tomographic Techniques," *Am. J. Card.* 43:787, 1979.
 82. Wackers, F. J. T., et al., "Multiple-Gated Cardiac Blood Pool Imaging for Left Ventricular Ejection Fraction: Validation of the Technique and Assessment of Variability," *Am. J. Card.* 43:1159, 1979.
 83. _____, "Prevalence of Right Ventricular Involvement in Inferior Wall Infarction Assessed With Myocardial Imaging With Thallium-201

- and Technetium-99m Pyrophosphate, " *Am.J. Card.* 42:358, 1978.
84. Wackers, F. J. T., et al., "Value and Limitations of Thallium-201 Scintigraphy in the Acute Phase of Myocardial Infarction, " *N. Eng. J. Med.* 295:1, 1976.
85. Weiner, O. A., et al., "Exercise Stress Testing: Correlations Among History of Angina, ST-Segment Response and Prevalence of Coronary-Artery Disease in the Coronary Artery Surgery Study," *N. Eng. J. Med.* 301:230, 1979.
86. Weiss, E. S., et al., "Evaluation of Myocardial Metabolism and Perfusion With Positron-Emitting Radionuclides," *Progre. Card.* 20:191, 1977.
87. Zaret, B. L., et al., "A Non-Invasive Scintiphographic Method for Detection of Regional Ventricular Dysfunction in Man, " *N. Eng. J. Med.* 284:1165, 1971.
88. Zir, L. M., et al., "Interobserver Variability in Coronary Angiography," *Circulation* 53:627, 1976.